



Collection 2019

Mercedes-Benz



2



52



70



76

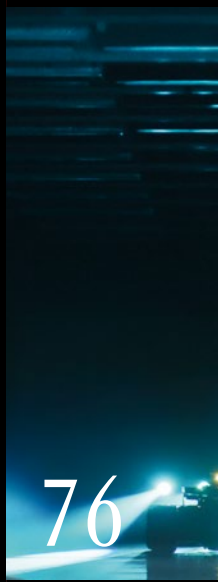

Contents



2	The Mercedes-Benz Collection
52	The Mercedes-Benz Classic Collection
64	The Mercedes-Benz Van Collection
70	The Mercedes-Benz Trucks Collection
76	The Mercedes-Benz Motorsports Collection
84	The Mercedes-AMG Collection

MEN'S CAGOULE¹

Black / grey blend. 100% polyester. Low weight. Longer cut back section with ventilation slits. Side pockets with water-resistant zippers. High-closing, water-resistant front zipper. Water-resistant taped seams. Hood adjustable in size and width. Cuffs and seam adjustable in width. Elastic cuffs with thumb hole on sleeve ends. Incorporated bag in the back section for compact storage of jacket. Modern fit. silver-coloured Mercedes star print on the left sleeve, black Autoblock zip puller with Mercedes star in 3D look, "Mercedes-Benz" lettering on the inside of the seam. Sizes: S-XXL.
B6 695 8701-8705

MEN'S POLO SHIRT

100% cotton. Short-sleeve shirt with spiral zip and black zip puller. Zip front with stylish bonding. Patterned neck and side groove bands. Single-rib collar and cuffs. Drop-tail cut. Modern fit. Sizes S-XXL.

Grey B6 695 8711-8715

Black (not shown) B6 695 8706-8710

¹ Available from June 2019.



SCAN THE QR CODE AND EXPERIENCE THE COLLECTION.

http://mb4.me/MBA_MB_Collection

Freestyle.

Casual meets chic. Elegance meets sportiness. Business meets leisure. The Mercedes-Benz Collection combines the elegance unique to our vehicles with superior sportiness. For all those who have nothing left to prove. And display the best of what makes life more beautiful: accentuated nonchalance.

3



THE MERCEDES-BENZ COLLECTION

1 LITE-BOX CASE 55

Dimensions approx. 40 x 20 x 55 cm.
Capacity approx. 38 l, weight approx. 2.2 kg.

Black B6 695 8486

Hyacinth red (not shown) B6 695 8489

Denim blue (not shown) B6 695 8483

2 LITE-BOX CASE 69

Dimensions approx. 46 x 27 x 69 cm.
Capacity approx. 75 l, weight approx. 2.7 kg.

Black B6 695 8487

Hyacinth red (not shown) B6 695 8490

Denim blue (not shown) B6 695 8484

3 LITE-BOX CASE 75

Dimensions approx. 52 x 75 x 31 cm.
Capacity approx. 93 l, weight approx. 3 kg.

Black B6 695 8488

Hyacinth red (not shown) B6 695 8491

Denim blue (not shown) B6 695 8485



4



WEEKEND BAG

Black. Polyurethane/polyester. Water-repellent. Large main compartment with 2-way zip. Zipped inner pocket. Adjustable, detachable shoulder belt. Volume approx. 60 l. Dimensions approx. 60 x 30 x 34 cm. B6 695 5033

MEN'S SPORT FASHION M3 CHRONOGRAPH

Stainless steel case with black PVD coating. Black dial. Hour and minute hands, as well as blue second hand with Super-LumiNova® detail. Anti-reflective mineral glass on both sides. Black nylon strap, blue woven coloured stripes running through the middle. Water-resistant to 10 ATM. Diameter 42 mm. Ronda 5030 quartz movement. Swiss made. B6 695 4061

1-3 LITE-BOX CASE

Highly impact-resistant material (Curv®). Functional interior trim with adjustable packing straps and two dividers. Smooth-running, silent double wheels. TSA lock. Incl. shoe bag and laundry bag. By Samsonite for Mercedes-Benz.



3

2

5

4 RUCKSACK

Black. Polyurethane/polyester. Water-repellent. Main compartment with 2-way zipper and various inner compartments. Zipped compartment on front. Padded back section. Trolley attaching function. Adjustable, padded shoulder belt. Carrying handle. Dimensions approx. 30x13x43 cm. B6 695 5032

5 UMBRELLA

See p. 14

4

5

1

Samsonite

Samsonite



1 MEN'S SOFTSHELL JACKET¹

Black / grey blend. 100% polyester. Wind- and water-repellent. High-closing collar. Width- and size-adjustable hood with zipper. Width-adjustable hem. Width-adjustable sleeve end with inside cuffs with thumb hole. Strap for headphones cable. Modern fit. Sizes: S-XXL. B6 695 8696-8700

2 MEN'S WINTER PARKA

Black. Outer material and padding 100% polyester, taffeta lining 100% nylon. Water- and wind-resistant. 2-way front zip closing. Detachable width- and size-adjustable hood. Adjustable hem. Adjustable cuffs. Various pockets. Size S-XXXL. B6 787 1177-1182

1-2

6

3 MENS JACKET

Black. 100% polyester. Water-repellent. Chin guard. Width adjustable at lower edge. Loop for earphone cable inside. Various pockets. Sizes S-XXL. B6 695 8399-8403

4 MEN'S JACKET

Navy. 100% polyester. Design details from the diamond radiator grille. Wind-resistant. High-closing collar. Removable and stowable hood. Various pockets. Modern fit. Sizes S-XXL. B6 695 8576-8580

5 FLAT BRIM CAP

Black. Underside of brim in silver grey. 80% polyacrylic/20% wool. 6-panel. Adjustable fit. B6 695 3170

6 CAP

Black. Cotton. Adjustable fit. B6 695 4531

7 LADIES' CAP

Black. 100% cotton. Peached outer material. Adjustable fit. B6 695 4533

8 CAP

Anthracite. Polyester. Water-repellent outer material, perforated Mercedes star. Adjustable fit. B6 695 4291



3-4



5-8

¹ Available from June 2019.



9

9 MEN'S POLO SHIRT

Dark red with navy contrasts. 65% cotton/35% polyester. Polo collar and cuffs with woven-in stripes and texture. Half-moon in fancy-flake yarn on the inside of the collar. Two-tone buttons, neck and side groove bands with detailed design from diamond radiator grille. Slim Fit. Sizes S-XXL. B6 695 8581-8585

10 MEN'S T-SHIRT

Black. 95% cotton/5% elastane. Slim-fit. Sizes S-XXL. B6 695 8319-8323

11 MEN'S T-SHIRT

Navy with dark red contrasts. 95% viscose/5% polyester. Narrow crew neck in single rib. Sleeves with a turnover fold. Taped chest pocket. Contrasting topstitching in multi-coloured thread on the back and on the seam. Slim-fit. Sizes S-XXL. B6 695 8586-8590

12 MEN'S T-SHIRT

100% Supima cotton. Short V-neck. Tonal neck band with silver grey stripe. Modern fit. Sizes: XS-XXL.

White B6 695 8722-8727

Black (not shown) B6 695 8716-8721

13 LADIES' BLOUSE-STYLE SHIRT

Black. Front section 75% viscose/25% silk, sleeves and back 100% viscose. Short sleeves. Side vents. Modern fit. Tonal, embroidered Mercedes star on the left upper arm. Sizes XS-XL. B6 695 8661-8665



10-12

14 LADIES' JACKET

Black/gold-coloured. Outer material 100% polyester, taffeta lining 55% polyester/45% viscose. Sewn-on pockets. Zipped chest pockets. Drawcord for adjustable waist width. Elastic ribbed inserts around the waist. Stand-up collar and cuffs with single rib. Modern fit. Embroidered, tonal Mercedes star on circular badge on the left sleeve. Black band with woven, golden identity pattern on the inside at the drawstring around the waist. Sizes XS-XL. B6 695 8656-8660

15 LIFESTYLE SUNGLASSES

Brown-blue transparent acetate frame. Grey lenses by Carl Zeiss Vision. 100% UV-A/UV-B protection (UV-400). Filter category 3. Anti-reflective coating. B6 695 3501

16 WOMEN'S LIFESTYLE SUNGLASSES

Gold-coloured stainless steel version with Havana brown acetate glass enclosure and navy blue acetate earpieces. Brown lenses by Carl Zeiss Vision. 100% UV-A/UV-B protection (UV-400). Filter category 3. Anti-reflective coating. B6 695 3488



13-14



15-16



1

1 MEN'S JACKET¹

Navy. Outer material: 93% new wool / 7% polyurethane, inner lining mesh / taffeta lining: 100% polyester. Seam and cuffs with textured knit. Knitted collar with catch and press stud fastener. Front zipper fastening. Zipped, angled side pockets. Zipped inner pocket. Slim fit. By Tommy Hilfiger for Mercedes-Benz. Sizes: S-XXL. B6 695 8818-8822



2

2 MEN'S POLO SHIRT¹

100% cotton piqué with cooling accoutrements (ClimaCool) Single rib collar and cuffs. Side vents. Drop-tail cut Slim fit. By Tommy Hilfiger for Mercedes-Benz. Sizes S-XXL.

Red B6 695 8813-8817

White (not shown) B6 695 8808-8812

3 MEN'S GILET¹

Grey blend. 84% polyester / 16% viscose. Lining and wadding: 100% polyester. Knitted collar with catch and press stud fastener. Front zip fastening. Seam and cuffs with textured knit and embroidered stripes. Zipped, angled side pockets. Zipped inner pocket. By Tommy Hilfiger for Mercedes-Benz. Sizes: S-XXL. B6 695 8823-8827



3

All products on this page

TOMMY HILFIGER



4-5

4 MEN'S SWEAT HOODY¹

Navy. 89% cotton/11% polyester. Hood with drawstring and striped cord ends. Corded neck ribbon with woven stripes. Front kangaroo pocket. Sleeve and hem rounded off with single rib with embroidered stripes. Slim fit. By Tommy Hilfiger for Mercedes-Benz. Sizes: S-XXL. B6 695 8803-8807

5 MEN'S SWEAT PANTS¹

Navy. 89% cotton/11% polyester. Elastic seam with drawstring and striped cord ends. Hem rounded off with single rib with embroidered stripes. Slim fit. By Tommy Hilfiger for Mercedes-Benz. Sizes: S-XXL. B6 695 8828-8832



1 SHOPPING BAG

Imitation leather. Removable inside zip pocket.
Press-stud fastening.
Dimensions approx. 36 x 15 x 35 cm.

Red/gold-coloured B6 695 3713

Blue/silver-coloured (not shown) B6 695 3714

Silver-coloured/black (not shown) B6 695 3712

2 CREDIT CARD HOLDER

Black. Cowhide. Various compartments.
RFID protection. Mercedes star embossing.
Dimensions approx. 12 x 2 x 9 cm.

B6 695 3719



3 CROSS-BODY BAG

Black. Cowhide. Small inner compartment.
Adjustable carrier belt. Small buckle with
Mercedes star. By BREE for Mercedes-Benz.
Size approx. 19 x 6 x 13 cm. B6 695 4156

4 LADIES' PURSE

Greige. Cowhide. All-round metal zipper.
Various compartments for notes, coins and cards.
Dimensions approx. 11 x 11 cm. B6 695 5035

5 LADIES' RUCKSACK

Greige. Cowhide. Large main compartment with
inside pocket. Drawcord and additional toggle catch.
Adjustable shoulder straps. Mercedes-Benz
embossing on the inside pocket, Mercedes star stud
on cord stopper. Dimensions approx. 28 x 14,5 x 32 cm.
B6 695 5034





6

6 MINI PURSE

Black. Leather. RFID protection. Various note, coin, card compartments and pockets. With embossed Mercedes star. Dimensions approx. 10.5x2x7 cm. B6 695 3718

7 SHOPPING BAG

Grey. 100% polyester felt. Carrying handles in seat belt material. Zipped inner pocket with snap hook. Dimensions approx. 26x14x40 cm. B6 695 2989



7

8 SHOPPING BAG

Polyester. Genuine leather detail. Large main compartment and various inner compartments. Removable cosmetics bag. Mercedes-Benz proprietary pattern stitching. Dimensions approx. 51 x 22 x 34 cm.

Cherry tomato B6 695 4704

Nebulus blue (not shown) B6 695 4787



8



9-11

9 HANDBAG

Blue. Polyurethane. Various inside pockets. Zipper pocket on back. With pulling strap and small D-ring to attach the key ring. Mercedes star embossing on front. By Fritzi aus Preußen for Mercedes-Benz. Dimensions approx. 36x15x32 cm. B6 695 3729

10 WALLET

Blue. Polyurethane. Various compartments for notes, coins and cards. By Fritzi aus Preußen for Mercedes-Benz. Dimensions approx. 19x3x11 cm. B6 695 3728

11 LOVE KEY RING

Blue/red. Leather/die-cast zinc. Flat split ring with three mini split rings for quick removal/replacement of individual keys. Length approx. 14 cm. B6 695 3619

1



2



3



4



LAMY
Design. Made in Germany.

eva solo

12

5



1 WALLET

Black. Cowhide. RFID protection. Various compartments inside. Mercedes star embossing. Dimensions approx. 10x2x12 cm. B6 695 3717

2 TO-GO CUP

Silver-coloured/black. Stainless steel. Double-walled. Functional drinking cap. Silicone wrist strap with raised, embossed Mercedes-Benz lettering. Laser-engraved Mercedes star. By eva solo for Mercedes-Benz.

Diameter approx. 6.5 cm, height approx. 20 cm.

Capacity approx. 0.35 l. B6 695 5013

Diameter approx. 7.5 cm, height approx. 20 cm.

Capacity approx. 0.5 l. B6 695 5014

3 A-CLASS KEY RING

See p. 13

4 LAMY LOGO BALLPEN

Barrel in Mercedes-Benz paintwork colour. Plastic/stainless steel. Push-action. Takes LAMY M 16 large-capacity refills. Silver-coloured Mercedes-Benz logo print on barrel. In decorative test tube packaging. By LAMY for Mercedes-Benz. Made in Germany. **Cosmos black, blue ink B6 695 4239**

5 CASUAL SUNGLASSES

Black/transparent acetate frame. Lenses with grey colour gradient by Carl Zeiss Vision. 100% UV-A/UV-B protection (UV-400). Filter category 3. B6 695 3487



6



7-8



9-10

eva solo



11

LAMY
Design. Made in Germany.

11 LAMY LOGO BALLPEN

See p. 12

Hyacinth red, blue ink B6 695 4238

Denim blue, blue ink (not shown) B6 695 3419

Diamond white, black ink (not shown)

B6 695 3087

Mountain grey, black ink (not shown)

B6 695 3652

12 CRYSTAL PENCILS, SET-OF-5

Black. Wood/glass. Writes in black. One Swarovski® crystal in either white, blue, green, red or black respectively on the front of the pencil. Made for Mercedes-Benz by Swarovski®. Length approx. 17.5 cm. B6 695 4462



12



6 EQ KEY RING¹

Silver/black/blue. Stainless steel/plastic. "Coming Home" function. Key ring with special, easy-to-open lock. Three additional mini split rings for quick removal/replacement of individual keys. Length approx. 9 cm. B6 695 3963

7 TYPO EQC KEY RING

Silver-coloured/black/blue. Stainless steel/luminous material. Front features replica of original lettering on rear of vehicle, back features 3D star logo. Flat split ring with three additional mini split rings for quick removal/replacement of individual keys. Designed in Germany. Length approx. 9 cm. B6 695 3962

8 TYPO KEYCHAIN

Black/silver-coloured. Stainless steel. Flat keyring with 3 smaller split rings for quick removal/replacement of individual keys. Front features replica of original lettering on rear of vehicle, back features 3D star logo. Designed in Germany. Length approx. 9 cm.

A-Class (p. 12) B6 695 8414

B-Class (not shown) B6 695 8415

C-Class (not shown) B6 695 8416

E-Class (not shown) B6 695 8417

G-Class (not shown) B6 695 8418

S-Class (not shown) B6 695 8419

V-Class (not shown) B6 695 8420

X-Class (not shown) B6 695 3618

SL B6 695 8421

CLA (not shown) B6 695 8422

CLS (not shown) B6 695 8423

GLA (not shown) B6 695 8424

GLC (not shown) B6 695 8425

GLE (not shown) B6 695 8426

GLS (not shown) B6 695 8427

SLC (not shown) B6 695 8428

9 MYFLAVOUR DRINKING BOTTLE, 0.75 L

Transparent/silver. Tritan. Skewer for fruits. Practical carrying loop. Dishwasher safe. Laser-engraved Mercedes star. By eva solo for Mercedes-Benz. Diameter approx. 7.5 cm, height approx. 25.5 cm. Capacity approx. 0.75 l. B6 695 5015

10 TO GO TEA MUG, 0.35 L

Black. Stainless steel. Double-walled. Functional drinking cap with brewing unit. Silicone wrist strap with raised, embossed Mercedes-Benz lettering. Laser-engraved Mercedes star. By eva solo for Mercedes-Benz. Diameter approx. 7.5 cm, height approx. 17.5 cm. Capacity approx. 0.35 l. B6 695 5083

¹ Available from June 2019.



1 CONVENTIONAL UMBRELLA, STRETCH

Steel shaft. Plastic hook handle. Fibreglass rails. Windproof design. Automatic guest umbrella with automatic extension of canopy on all sections. Tonal Mercedes star print, hook handle with star badge. Length approx. 82 cm. Diameter when open approx. 130 cm.

- Red/orange B6 695 4814
- Orange/yellow B6 695 4815
- Petrol/mint B6 695 4816
- Purple/lilac B6 695 4817



2 GUEST UMBRELLA

Black. Water and dirt-repellent canopy. Aluminium shaft. Windproof. Automatic opening. Diameter when open approx. 130 cm. B6 695 2630



4 UMBRELLA

Transparent/black. Aluminium/polyethylene. Special-coated plastic handle. Automatic opening. Fastening tab with Velcro fastener. Windproof. Inset star badge in the handle. Diameter when open approx. 105 cm. B6 695 4529

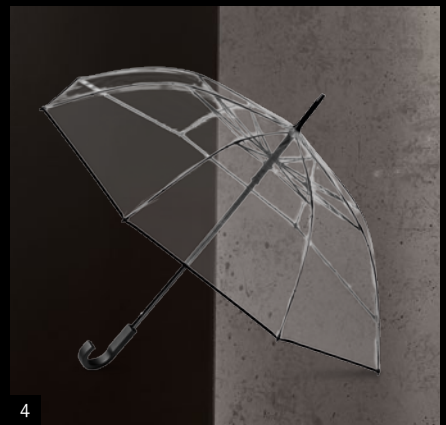

3 COMPACT UMBRELLA

Black. Water and dirt-repellent canopy. Chromed steel shaft. Windproof. Automatic opening and closing. Length approx. 30 cm, diameter when open approx. 97 cm. B6 695 2631

5 UMBRELLA

Black. Water and dirt-repellent canopy. Aluminium shaft. Windproof. Automatic opening. Diameter when open approx. 105 cm. B6 695 2629



6 COVER FOR iPhone® 7/iPhone® 8

White/silver-coloured. Plastic/aluminium.
Wireless charging function is not supported.
B6 695 3560

7 COVER FOR iPhone® 7/iPhone® 8

In alubeam silver. Plastic. Wireless charging
function is not supported. B6 695 3561

8 BOOK-TYPE COVER

Polycarbonate/cowhide. Fashionable stitching.
Apertures for camera, buttons and connections.
3D Mercedes star. Suitable for NFC tags and
wireless charging.

iPhone® X/iPhone® XS

Black (not shown) B6 695 8598

Blue (not shown) B6 695 8599

iPhone® 7 Plus/iPhone® 8 Plus

Black (not shown) B6 695 8615

Blue (not shown) B6 695 8617

iPhone® 7/iPhone® 8

Black B6 695 8614

Blue (not shown) B6 695 8616

Samsung Galaxy S8

Black (not shown) B6 695 8606

Blue (not shown) B6 695 8607

9 CASE FOR SAMSUNG GALAXY S8

Black. Polycarbonate. Soft-touch material.
Aperture for camera, control buttons and
connections. 3D star. Suitable for wireless
charging. B6 695 3799

10 COVER FOR iPhone® 7/iPhone® 8

Plastic. Suitable for wireless charging.

Black B6 695 3239

White (not shown) B6 695 3240



6-7



9



11



8



10



12

11 COVER

Black. Polycarbonate/microfibre. Apertures
for camera, buttons and connections.
3D Mercedes star. Suitable for wireless charging.

iPhone® X/iPhone® XS B6 695 3638

iPhone® XR (not shown) B6 695 5205

12 COVER

Polycarbonate/cowhide. Apertures for
camera, buttons and connections.
Suitable for NFC tags and wireless charging.

iPhone® X/iPhone® XS

Black (not shown) B6 695 8600

Blue (not shown) B6 695 8602

Grey (not shown) B6 695 8601

iPhone® 7 Plus/iPhone® 8 Plus

Black (not shown) B6 695 8619

Blue (not shown) B6 695 8621

Grey (not shown) B6 695 8623

iPhone® 7/iPhone® 8

Black (not shown) B6 695 8618

Blue (not shown) B6 695 8620

Grey (not shown) B6 695 8622

Samsung Galaxy S8

Black (not shown) B6 695 8603

Blue (not shown) B6 695 8604

Grey B6 695 8605



1



2



3



4

1 BILBAO KEY RING

Black/silver. Leather/stainless steel. Flat split ring with three additional mini split rings for quick removal/replacement of individual keys. Length approx. 12 cm. B6 695 3823

2 LAS VEGAS KEY RING

Silver-coloured/black. Stainless steel. Luminous finish in the inner contours. Flat split ring with three mini split rings for quick removal/replacement of individual keys. Length approx. 9 cm. B6 695 8326

3 BRUSSELS KEYCHAIN

Die-cast zinc with high-sheen polished finish. Rotating Mercedes star. Flat keyring with 3 smaller split rings for quick removal/replacement of individual keys. Length approx. 9 cm.

Silver-coloured B6 695 7516

Gold-coloured (not shown) B6 695 3741

4 UNTERTÜRKHEIM KEY RING

Black/silver-coloured. Stainless steel. Flat split ring with three mini split rings for quick removal/replacement of individual keys. Made in Germany. Length approx. 7 cm. B6 695 3307



5

5 CAPE TOWN KEY RING

Black/silver-coloured. Stainless steel. Snap hook with three mini split rings for quick removal/replacement of individual keys. Design based on the Mercedes-Benz radiator grille. Length approx. 5.5 cm. B6 695 6711

6 PRAGUE KEY RING

Rose gold colours. Stainless steel/mother-of-pearl/PVD coated. Link chain. Key ring with special, easy-to-open lock. Three additional mini split rings for quick removal/replacement of individual keys. Length approx. 10 cm. B6 695 3744



6



7-8



9

7 TOKYO WATCH STRAP

Glass/stainless steel. Made for Mercedes-Benz by Swarovski®. Length approx. 41.5 cm.

Red/silver-coloured B6 695 4719

Black/silver-coloured (not shown) B6 695 4718

8 TOKYO KEYCHAIN

Stainless steel. Adorned with Swarovski® crystals. Flat keyring with 3 smaller split rings for quick removal/replacement of individual keys. Made for Mercedes-Benz by Swarovski®. Length approx. 9 cm.

Black/silver-coloured B6 695 4716

Red/silver-coloured (not shown) B6 695 4717

9 ST. TROPEZ KEYCHAIN

Stainless steel. Background adorned with Swarovski® Crystal Fine Rocks. Flat keyring with 3 smaller split rings for quick removal/replacement of individual keys. Length approx. 9 cm.

Silver-coloured/red B6 695 9999

Silver-coloured/black (not shown) B6 695 2740

Silver-coloured/blue (not shown) B6 695 3429

Silver-coloured/white (not shown) B6 695 9998



10

10 DOG'S CUSHION, BY MIACARA®¹

Grey. Polyester/polyurethane. Cover can be removed and washed.

Made for Mercedes-Benz by MiaCara®. Sizes S-L. B6 695 8838-8840

11 DOG COLLAR, BY MIACARA®¹

Grey. Leather/stainless steel. Buckle. Made in Italy.

Made for Mercedes-Benz by MiaCara®. Sizes S-L. B6 695 8833-8835

12 DOG LEASH, BY MIACARA®¹

Grey. Saffiano leather. Adjustable to two lengths with snap hook.

Mercedes star stitching on lower end. Made in Italy. Made for Mercedes-Benz by MiaCara®. Total length approx. 1.95 m. B6 695 8836



11



12

¹ Available from April 2019.

Mercedes-Benz Select.

The new fragrance for men.



INCC - Licensee of Daimler AG

18

Mercedes-Benz



1 MERCEDES-BENZ PERFUME SELECT

Eau de toilette. Men's fragrance.

Contents approx. 50 ml (illustration p. 18)

B6 695 8767

Contents approx. 100 ml (not shown)

B6 695 8766

2 MERCEDES-BENZ WOMEN'S PERFUME

Eau de toilette. Ladies' fragrance. Atomiser.

Contents approx. 30 ml (not shown) B6 695 8770

Contents approx. 60 ml B6 695 8769

3 MERCEDES-BENZ ROSE PERFUME

Eau de toilette. Ladies' fragrance. Atomiser.

Contents approx. 30 ml B6 695 8574

Contents approx. 60 ml (not shown) B6 695 8573



2



3



4-6

19



7

7 MERCEDES-BENZ LE PARFUM PERFUME

Eau de parfum. Cologne. Atomiser.

Contents approx. 120 ml B6 695 8568

4 MERCEDES-BENZ MEN'S PERFUME

Eau de toilette. Men's fragrance. Atomiser.

Contents approx. 40 ml

B6 695 8372

Contents approx. 75 ml (not shown)

B6 695 8225

5 MERCEDES-BENZ COLOGNE PERFUME

Eau de toilette. Men's fragrance. Atomiser.

Contents approx. 40 ml (not shown)

B6 695 8571

Contents approx. 75 ml

B6 695 8570

6 MERCEDES-BENZ MEN'S PERFUME

Eau de toilette. Men's fragrance. Atomiser.

Contents approx. 50 ml (not shown)

B6 695 8631

Contents approx. 100 ml

B6 695 8630



1-2

1 WOMEN'S WRISTWATCH, BASIC

Stainless steel case with rose gold-coloured PVD coating. Mother-of-pearl dial. Rose gold-coloured hands with Super-LumiNova® detail. Anti-reflective mineral glass on both sides. Beige leather strap, black paintwork on the cut edges. Diameter 35 mm. Ronda 702 quartz movement. B6 695 4184

2 MEN'S WRISTWATCH, BASIC

Stainless steel case. Brilliant blue dial. Steel-coloured hour and minute hands, red second hand, tips with Super-LumiNova® detail, four double indices. Anti-reflective mineral glass on both sides. Black calfskin strap. Water-resistant to 10 ATM. Diameter 40 mm. Ronda 513 quartz movement. B6 695 4177

20

3 SMARTWATCH, GARMIN VIVOACTIVE 3

Plastic/stainless steel/silicone. Colour touchscreen display. Mercedes-Benz branding on back of case, inside of strap and pushbutton. Dials fashioned exclusively in Mercedes-Benz design. Compatible with Android and Apple. Battery life GPS mode approx. 13 hours, smartwatch mode up to 7 days. Measurement of vital signs and stress levels, suggestions for activation of vitality and relaxation programmes. Garmin Pay™ support. Compatible with Garmin Connect™ mobile app. Water-resistant to 5 ATM. Diameter 43.4 mm.

Installed language settings:

Black B6 695 8847, **white** B6 695 8853: Danish, Dutch, Finnish, English (US), French (FR), Italian, German, Norwegian, Spanish, Swedish, Portuguese (BZL), Portuguese (PT)

Black B6 695 8848, **white** B6 695 8854: English (US), Russian, Czech, Hungarian, Polish, Slovakian, Hebrew

Black B6 695 8849, **white** B6 695 8855: English (US), Greek, Arabic, Turkish, Croatian, Slovenian

Black B6 695 8850, **white** B6 695 8856: Simplified Chinese, English (US)

Black B6 695 8851, **white** B6 695 8857: Japanese, English (US)

Black B6 695 8852, **white** B6 695 8858: Korean, English (US)



3

GARMIN

4 WALL CLOCK

Silver-coloured. Aluminium dial and case. Black numerals. Quartz movement. Thermometer and hygrometer function. Diameter approx. 30 cm. B6 787 0476



4



USE THE WALLET FUNCTION OF YOUR SMARTPHONE

Simply scan the QR code and you will have the opportunity to clearly store the high-quality personal accessories from the Mercedes-Benz Collection on your mobile phone. Once stored, you are always up to date, wherever you are.

5 WOMEN'S SPORT FASHION CHRONOGRAPH M3

Stainless steel case with rose gold-coloured PVD and white ceramic bezel. White dial with pink gold-coloured applications. Rose gold-coloured hands with Super-LumiNova® detail. Swarovski® crystals as hour markers. Anti-reflective mineral glass on both sides. White calfskin strap. Water-resistant to 10 ATM. Diameter 39 mm. Ronda 5030 quartz movement. Swiss made. B6 695 4170



5



6

6 LADIES' WATCH, GLAMOUR

Silver/black. Stainless steel case. Black dial with eight Swarovski® crystals as hour markers and black Swarovski® Crystal Fine Rocks in centre. Silver-coloured luminous hands. Mineral crystal. Black calfskin wristband. Water-resistant to 5 ATM. Diameter 37 mm. Miyota GM10 quartz movement. B6 604 1922



7

7 WOMEN'S FASHION GOLD WRISTWATCH

Stainless steel case with gold-coloured PVD coating. Blue dial trimmed with six Swarovski® crystals. Blue leather/textile strap. Yellow/gold-coloured hands. Water-resistant to 5 ATM. Diameter approx. 35.5 mm. Ronda 1002 Swiss movement. Swiss movt. B6 695 3564

MEN'S FUNCTIONAL COAT

Silver-grey. 100% polyamide outer material, 100% polyester inner lining. Bonded inner seams. Hood with zipper. Concealed snap fastening. Side flap and water-resistant zipped pockets. Zipped breast pocket with outlet for headphones cable. Width-adjustable sleeves. Modern fit. Sizes: S-XXL. B6 695 8681-8685

MEN'S MERCEDES-BENZ AUTOMATIC WRISTWATCH

Stainless steel case with polished and matt finish. Black dial with blue minute markers. Silver-coloured hands and indices with Super-LumiNova® detail.

Anti-reflective sapphire glass on both sides. Stainless steel strap with polished and matt finish. Date feature. Water-resistant to 10 ATM. Diameter 43 mm. ETA 2824 automatic movement. Swiss made. B6 695 3968

MEN'S BELT

Black. Italian calfskin. Adjustable fit. Length approx. 125 cm, width approx. 3.4 cm. B6 695 3047

MEN'S POLO PULLOVER

See p. 27



MEN'S SUNGLASSES, BUSINESS

Anthracite-coloured stainless steel version with black acetate earpieces. Hardened lenses with grey colour gradient and with ANTI-REFLECTION coating by Carl Zeiss Vision. 100% UV-A/UV-B protection (UV-400). Filter category 3. B6 695 3486

BUSINESS BAG

Black. Leather/nylon. Two large main compartments, various inner and side compartments. Detachable, adjustable shoulder belt. Strap at back for slotting over towbar of trolley suitcase. By BREE for Mercedes-Benz. Dimensions approx. 41 x 11 x 30,5 cm. B6 695 2885



Business class.

Our collection for your professional life is distinctively characterised by Mercedes-Benz style. Carefully manufactured pens, discreet jewellery as well as stylish chronograph watches are characterised by the finest materials and finishes. Each of the items perfectly tailored to your everyday working life receive their finishing touches by their use in your private life.





1 LAPTOP BAG

Black. Polyester/nylon/polyurethane. Large main compartment with removable laptop compartment for laptops up to approx. 40.6 cm (16 inches). Expandable front compartment with tablet compartment and space for documents. Outer compartment with practical partitioning. Two carrying handles. Detachable shoulder strap. Smart sleeve for secure transport on top of suitcase. By Samsonite for Mercedes-Benz. Dimensions approx. 45 x 16/19 x 33 cm. Capacity approx. 18/21.5 l. Weight: approx. 1.1 kg. B6 695 8844

1



3

2 PILOT SUITCASE

Black. Polyester/nylon/polyurethane. Large main compartment with padded laptop compartment for laptops up to approx. 43.9 cm (17.3 inches), tablet compartment and separate compartment with packing straps for clothing or documents. Zipped outside pocket and practical partitioning. Two robust double rollers. Cabin-ready dimensions. By Samsonite for Mercedes-Benz. Dimensions approx. 48 x 22 x 40 cm. Capacity approx. 32 l. Weighs approx. 3 kg. B6 695 8845

2

3 WASH BAG

Black. Polyester/nylon/polyurethane. Main compartment with various internal pockets. Small zipped outer compartment. Hook for hanging. By Samsonite for Mercedes-Benz. Dimensions approx. 25 x 11 x 23 cm. Capacity approx. 6 l. Weight: approx. 0.3 kg. B6 695 8846



4

All products on this page

Samsonite

4 X'BLADE SUITCASE

Black. Polyester/nylon/polyurethane. Large main compartment with compression packing belt. Three zipped outer compartments Wet pocket on the inside of the lid. TSA lock. Double rollers. With additional bag. Cabin-ready dimensions. By Samsonite for Mercedes-Benz.

X'BLADE 71 SUITCASE

Dimensions approx. 45 x 29/34 x 71 cm, volume approx. 88 l/95 l, weight approx. 3.4 kg. B6 695 8843

X'BLADE 63 SUITCASE

Dimensions approx. 42 x 27/31 x 63 cm, volume approx. 66 l/72 l, weight approx. 2.8 kg. B6 695 8842

X'BLADE 55 SUITCASE¹

Dimensions approx. 40 x 20 x 55 cm, volume approx. 41 l, weight approx. 2.5 kg. Suitable as cabin luggage. B6 695 8841

¹ Not necessarily applicable with all airlines. Please check the individual airline's hand luggage restrictions.

1 PIN, LAUREL LEAF BADGE

Stainless steel. The motif adorns the laurel leaf badge found on Mercedes-Benz passenger car model series. Butterfly clasp and anti-twist lock on back. Diameter approx. 1 cm. B6 695 3551

2 BADGE, MERCEDES STAR

Polished stainless steel. Butterfly clasp and anti-twist lock on back. Diameter approx. 1 cm. B6 695 3080



1-2



3

3 GUEST UMBRELLA¹

Black. 100% polyester canopy. Aluminium shaft. Fibreglass ribs. Two-piece exclusive handle. Automatic opening. Water and dirt-repellent coating. Windproof. Diameter when open approx. 120 cm. B6 695 4412

4 MEN'S BUSINESS CHRONOGRAPH WATCH

Stainless steel case, with part black PVD coating. Black dial with sunray embossing in the counter eyes and steel-coloured hour markers with Super-LumiNova® luminous detail. Luminous hands. Water-resistant to 10 ATM. Diameter approx. 42 mm. Ronda 5030 Swiss quartz movement. Swiss made. B6 695 3530



5



4



6

5 RUCKSACK¹

Black. Polyester/cowhide details. Various compartments on inside and outside. 2-way zip fastening. Trolley connection system. Can be used as a rucksack and bag. Padded rear. Mercedes star stud. Dimensions approx. 40.5 x 15 x 30.5 cm. B6 695 4122

6 PAPERWEIGHT

Silver shadow/chrome/black. Die-cast zinc. All-round chromed plastic clasp. Base underside with foam rubber coating. Original radiator grille star from the vehicle. Mercedes-Benz form language designed in Germany. Dimensions approx. 13 x 13 x 13 cm. B6 695 4610

¹ Available from May 2019.



7-8

7 MEN'S POLO SHIRT

Light grey blend/dark green. 100% mercerised cotton. Single-rib, knitted pattern collar and cuffs featuring contrasting stripes. Woven neckband with identity pattern. Modern fit. Sizes S-XXL. B6 695 8686-8690

8 MEN'S POLO PULLOVER

Dark grey blend. 100% merino wool. Collar, seam and cuffs with single rib. Modern fit. Sizes: S-XXL. B6 695 8691-8695

9 MEN'S BELT

Brown. 100% leather. Adjustable fit. Length approx. 125 cm. Width approx. 3,4 cm. B6 695 4117



9

10 BUSINESS CARD HOLDER

Black. Italian calfskin. Various compartments inside, plus pocket on back. Suitable for bank cards, credit cards, business cards or loyalty cards, up to 9 x 6 cm. Dimensions approx. 11 x 1.5 x 7.5 cm. B6 695 2884

11 MINI CREDIT CARD HOLDER

Black. Italian calfskin. 3 slots for approx. 6 cards. Dimensions approx. 10 x 0.6 x 7.5 cm. B6 695 1619

12 CREDIT CARD HOLDER WITH MONEY CLIP

Black. Calfskin. RFID protection. Eight credit card slots. Mercedes star stud. Dimensions approx. 11 x 1 x 9 cm. B6 695 3959

13 WALLET

Black. Calfskin. RFID protection. Various compartments for notes, coins and cards. Mercedes star stud. Dimensions approx. 12.5 x 2 x 10 cm. B6 695 3960

14 I-CLIP THE WALLET

Black with silver-coloured details. Plastic/cowhide. Patented card system. For up to 12 cards. Money clip. Made in Germany. Dimensions approx. 8.7 x 6 x 1.6 cm. B6 695 4769



10



11



12



13



14

I-CLIP
THE WALLET



1 POWERBANK, 5,000 MAH¹

Black / silver-coloured. Plastic. Capacity of 5,000 mAh. Two USB ports. Lithium-polymer battery. On/Off switch. Four LEDs for displaying the charge progress. With micro USB cable. Dimensions approx. 11 x 1.5 x 6.6 cm. B6 695 3522

1



2



3

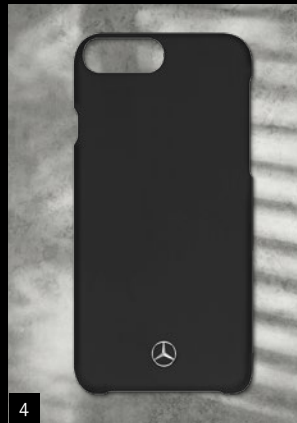

4

2 COVER FOR SAMSUNG GALAXY S8 BOOKTYPE

Black. Polycarbonate/cowhide. Aperture for camera, control buttons and connections. 3D star. Suitable for wireless charging. B6 695 3798

3 COVER FOR iPhone® 7/iPhone® 8

Black. Plastic/cowhide. Suitable for wireless charging. B6 695 4094

4 iPhone® 7 PLUS/iPhone® 8 PLUS COVER

Black. Plastic/cowhide. Aperture for camera, control buttons and connections. 3D star. Suitable for wireless charging. B6 695 4139

¹ Available from April 2019.

5



Lanybook®

6



LAMY
Design. Made in Germany.

8



LAMY
Design. Made in Germany.

7



9



5 LANYBOOK, LARGE
See p. 30

6 LAMY STUDIO FOUNTAIN PEN
Black. Stainless steel. Writes in blue. Refillable. Shiny black Mercedes-Benz lettering on the shaft below the clip. By LAMY for Mercedes-Benz. B6 695 4774

7 MOSCOW KEY RING
Black/silver. Leather/stainless steel. Embossed leather key ring with crocodile grain. Flat split ring with three additional mini split rings for quick removal/replacement of individual keys. Length approx. 10 cm. B6 695 3743

8 LAMY STUDIO BALLPOINT PEN Black. Stainless steel. Writes in black. Twist-action. Refillable. Shiny black Mercedes-Benz lettering on the shaft below the clip. By LAMY for Mercedes-Benz. B6 695 4773

9 USB FLASH DRIVE, GEN. 6. 32 GB, USB 3.0
In the shape of Mercedes-Benz Gen 6 vehicle key. 32 GB. USB 3.0 interface. Compatible with all standard operating systems. Dimensions approx. 3 x 1.4 x 6 cm.
White/silver-coloured
B6 695 4738
Black/silver-coloured
(not shown) B6 695 4737

1 LANYBOOK

Black. FSC paper®. 192 pages. Thread binding. Grey bookmark. Elastic pen loop. 3D star as Lanybutton, embossed Mercedes-Benz lettering on cover.

Small. Dimensions approx. 14 x 2 x 9 cm.
B6 695 3636

Large (illustration p. 29). Inner compartment with rear overlap. Dimensions approx. 24.7 x 2 x 17.5 cm.
B6 695 3637

2 ST. PETERSBURG KEY RING

Silver-coloured/black. Stainless steel/leather. Flat split ring with three additional mini split rings for quick removal/replacement of individual keys. Made in Germany. Length approx. 9 cm.
B6 695 3626

3 KEY SLEEVE CASE

Cowhide. Aperture for Mercedes star. Embossed Mercedes-Benz lettering. Dimensions approx. 4.6 x 1.9 x 8 cm.

White B6 695 8413

Black (not shown) B6 695 8412

4 KEY CASE

Cowhide/stainless steel. Magnetic fastener. Carabiner keyring with 3 smaller split rings for quick removal/replacement of individual keys. Dimensions approx. 4.6 x 2.3 x 8.4 cm.

White B6 695 8409

Black (not shown) B6 695 8408

Red (not shown) B6 695 8410

Carbon fibre leather (not shown) B6 695 8411

5 KEY CASE

Cowhide/stainless steel. Magnetic fastener. Flat keyring with 3 smaller split rings for quick removal/replacement of individual keys. Dimensions approx. 4.1 x 2.1 x 8.3 cm.

White B6 695 8405

Black (not shown) B6 695 8404

Red (not shown) B6 695 8406

Carbon fibre leather (not shown) B6 695 8407



6 KEY CASE

Black. Italian calfskin. Two leather straps with one large and one small split ring. With zipped compartment for small change on back. Dimensions approx. 11 x 2 x 7 cm. B6 695 2883

Lanybook®



7

BREE
SINCE 1970

7 WALLET

Black. Cowhide. RFID protection. Various compartments for notes, coins and cards. Mercedes star stud. By BREE for Mercedes-Benz. Dimensions approx. 19 x 3 x 10 cm. B6 695 3734



8

BREE
SINCE 1970

8 HANDBAG

Black. Cowhide. Various compartments. Leather tag with Mercedes star. By BREE for Mercedes-Benz. Dimensions approx. 37 x 18 x 26 cm. B6 695 3733

9 WOMEN'S WATCH, BUSINESS LADY

Stainless steel case. White dial with silver-coloured applications and Super-LumiNova® luminous dots. With date display and luminous hands. Water-resistant to 10 ATM. Diameter approx. 36.5 mm. Ronda 515 Swiss quartz movement. Swiss movt. B6 695 3532



9



1

1 DOG'S COLLAR CRYSTAL

Black/rose gold-coloured. Cowhide/glass/stainless steel. Leather inlaid with Swarovski® Crystal Fine Rocks. Made for Mercedes-Benz by Swarovski®.

Small

Length adjustable from 28–36 cm. B6 695 3953

Large

Length adjustable from 48–56 cm. B6 695 3954

2 CRYSTAL KEY RING

Rose gold-coloured/black. Stainless steel/glass. Flat split ring with three additional mini split rings for quick removal/replacement of individual keys. Key ring with black Swarovski® Crystal Fine Rocks. Made for Mercedes-Benz by Swarovski®. Length approx. 8 cm. B6 695 3577



2

3 WOMEN'S BUSINESS SUNGLASSES

Glossy gold frame with havanna-coloured acetate earpieces. Lenses with brown colour gradient, hardened and with ANTI-REFLECTION coating by Carl Zeiss Vision. 100% UV-A/UV-B protection (UV-400). Filter category 3. B6 695 3485

4 USB MEMORY STICK, 16GB, CRYSTAL

Rose gold/black. Plastic. Adorned with Swarovski® Crystal Ultrafine Rocks. 16 GB. USB 2.0 interface. Compatible with all standard operating systems. Made for Mercedes-Benz by Swarovski®. Dimensions approx. 4 x 3.6 x 1 cm. B6 695 4234



5



4

3



7



8



6

CRYSTAL JEWELLERY

Rose gold-coloured/black. Stainless steel/glass. Rounded off with Swarovski® crystal. Made for Mercedes-Benz by Swarovski®.

5 CRYSTAL NECKLACE

With extension chain. Length approx. 50 cm. B6 695 3578

6 CRYSTAL BRACELET

Length approx. 15.7 cm
B6 695 3584
Length approx. 16.7 cm
B6 695 3956

7 CRYSTAL RING

Size can be adapted by the jeweller. B6 695 3601

8 CRYSTAL NOTEBOOK

Black/rose gold-coloured. Cowhide/stainless steel/glass. High-quality fastener with Swarovski® Crystal Ultrafine Rocks. Inlay replaceable. Made for Mercedes-Benz by Swarovski®. Dimensions approx. 16.3 x 2.5 x 21.7 cm. B6 695 3602

MEN'S FUNCTIONAL SHIRT

See p. 36

MEN'S WINDCHEATER

Green. 100% nylon. Mesh sections under the arms. Hood with drawcord. Zipper with chin guard. Two zipped pockets. Reflective elements for best visibility. windCELL technology. Performance fit. By PUMA for Mercedes-Benz. Sizes: S-XXL. B6 695 8783-8787

MEN'S SPORTS PANTS

Blue/green. 100% polyester. Flexible waistband with drawcord. Side pocket with zipper. Reflective imprints on front and back. By PUMA for Mercedes-Benz. Sizes: S-XXL. B6 695 8778-8782



Athletic meets aesthetic.

Is it not sportiness that makes a Mercedes-Benz so unique? With the Mercedes-Benz Collection, we also pay tribute to this claim with fashion. Figure-accentuating cuts combined with materials that are as functional as they are beautiful exemplify pure athleticism – while exclusive details, such as the high-gloss Mercedes star or illuminating colours, exemplify unmistakable aesthetic appeal. Exclusive sports devices such as golf iron made from titanium round off the image in proper style.

All products on this page



SCAN THE QR CODE AND EXPERIENCE THE COLLECTION.

http://mb4.me/MBA_Sport_Collection

THE MERCEDES-BENZ COLLECTION

**MEN'S PERFORMANCE SHIRT**

Green. 100% polyester. Thermo-R technology. dryCELL technology wicks moisture perfectly away from the skin. Performance fit. By PUMA for Mercedes-Benz. Sizes: S-XXL. B6 695 8773-8777

1-2



1 LADIES' WINDCHEATER

Silver-coloured, 100% nylon. Mesh sections under the arms. Hood with drawcord. Adjustable waistline with drawcord. Water-repellant. windCELL technology. Laser cuts on the back for good ventilation. Performance fit. By PUMA for Mercedes-Benz. Sizes: XS-XXL. B6 695 8798-8802

2 LADIES' PERFORMANCE SHIRT

Peach colours. 100% polyester. Thermo-R technology. dryCELL technology wicks moisture perfectly away from the skin. Side mesh sections. Slim fit. By PUMA for Mercedes-Benz. Sizes XS-XL. B6 695 8788-8792



3

3 LADIES' SPORTS PANTS

Black. 77% polyester/23% elastane. 3/4 tight. Flexible waistband with drawcord. Pouch for valuables with zipper on the back. Reflective imprints on front and back. By PUMA for Mercedes-Benz. Sizes XS-XL. B6 695 8793-8797

A black KRAMSKI putter with a silver shaft is positioned on a vibrant green artificial turf. Three white golf balls, each featuring the Mercedes-Benz logo, are scattered on the grass. The background is a textured, light blue wall. A black rectangular box containing text is located in the upper right quadrant. A small inset image in the top right corner shows a close-up of a golf ball on a green.

“The best or nothing.” Gottlieb Daimler’s quote offers possibly the most fitting explanation for the powerful radiance of KRAMSKI PUTTER. With this approach, the brand has been able to establish itself in the golf scene and in tournament events as a standard for ultimate precision and perfection in just a few years.

Kramski HPP 325 MB.



The key features:

Striking surface	Plastic/metal mixture
Shaft	True Temper Double Bend
Putter head	Aluminium/carbide inserts
Colours	black, silver
Loft	3.25°
Lie	64-72°
Length	30-36 inch
High Precision Grip	S/M/L/XL/XXL

The individual and precise adjustment of the putter to the player is a significant part of the “Mastering the Green” philosophy of the brand. It takes place in a virtual fitting in the official KRAMSKI PUTTER Online Store.

Ordering and online fitting* directly at:

kramski-putter.com/mercedes-benz

39

The HPP 325 MB is based on the same high-precision putter model (HPP), with which two legendary 59 rounds have already been played on par 72 courses at professional tournaments. Precision milled and colour anodised, this sporty, tuned mallet with a high-tech insert captivates in such a way that it has won great popularity amongst KRAMSKI tour players. The HPP 325 MB is available as a right or left-hand model with a specially developed precision handle. A design putter cover made from the finest leather is included.



KRAMSKI PUTTER

*Fitting also possible in the KRAMSKI PUTTING ACADEMY: info@kramski-putter.com

1 MEN'S GOLF POLO SHIRT

Black. 83% polyester / 13% cotton / 4% elastane. 3-button fastening. Breast pocket. dryCELL technology. Performance fit. By PUMA for Mercedes-Benz. Sizes: S-XXL. B6 645 0332-0336

2 MEN'S GOLF POLO SHIRT

83% polyester / 13% cotton / 4% elastane. Three-button fastening. Breast pocket. dryCELL technology. Performance fit. By PUMA for Mercedes-Benz. Sizes S-XXL.

Black B6 645 0337-0341

Grey (not shown) B6 645 0342-0346



1-2



3-4



5



6-7

3 LADIES' GOLF TOP

Fuchsia. 92% polyester / 8% elastane. Stand-up collar with zip. dryCELL technology. Performance fit. By PUMA for Mercedes-Benz. Sizes XS-XL. B6 645 0364-0368

4 WOMEN'S GOLF POLO SHIRT

Fuchsia. 100% polyester. 5-button fastening. dryCELL technology. Performance fit. By PUMA for Mercedes-Benz. Sizes XS-XL. B6 645 0359-0363

5 CHILD'S GOLF POLO SHIRT

Green/black/white. 92% polyester / 8% elastane. 3-button fastening. dryCELL technology. Performance fit. By PUMA for Mercedes-Benz. Sizes 116-164. B6 645 0379-0383

6 MEN'S GOLF WIND JACKET

Black. 100% polyester. Water-repellant. windCELL technology. Zipper with chin guard. 2 zipped pockets. Performance fit. By PUMA for Mercedes-Benz. Sizes: S-XXL. B6 645 0352-0355

7 LADIES' GOLF WINDCHEATER

Black. 100% polyester. Water-repellant. windCELL technology. Two zipped side pockets. Fixable hood. Ventilation slit at the back. Performance fit. By PUMA for Mercedes-Benz. Sizes XS-XL. B6 645 0374-0378

All products on this page



8 GOLF SWEATER

64% nylon/36% polyester. Stand-up collar. dryCELL technology. evoKNIT technology. Venting elements in heat zones. Performance fit. By PUMA for Mercedes-Benz.

Women. Grey. Sizes XS-XL.
B6 645 0369-0373

Men. Black. Sizes S-XXL.
B6 645 0347-0351

9 MEN'S GOLF POLO SHIRT

91% polyester/9% elastane. Three-button fastening. dryCELL technology. Performance fit. By PUMA for Mercedes-Benz. Sizes S-XXL.

Orange/black/white B6 645 0327-0331

Green/black/white (not shown) B6 645 0322-0326

All products on this page



10 CHILD'S GOLF CAP

Green. 100% polyester. Snapback fastener. Moisture-absorbing performance sweatband. Embroidered "P" logo with 3D-effect. By PUMA for Mercedes-Benz. Adjustable fit. B6 645 0384

11 GOLF CAP

Black. 100% polyester. Snapback fastener. Moisture-absorbing performance sweatband on the inside. "P" embroidered logo in 3D effect. By PUMA for Mercedes-Benz. Adjustable fit. B6 645 0357

12 GOLF-CAP

Grey. 95% polyester/5% spandex. Moisture-absorbing performance sweatband on the inside. By PUMA for Mercedes-Benz. Adjustable fit. B6 645 0358



1-2

1 GOLF CART BAG

100% polyester. Compartments for 15 clubs with external putter pocket. Various pockets and pouches. Towel clip. Adjustable shoulder strap. Removable rain hood. Pass-through for cart strap for secure hold and easy access to pockets. By COBRA for Mercedes-Benz. Weight approx. 2.1 kg. Dimensions approx. 40x30x92 cm.

White/fuchsia/black B6 645 0386

Black (not shown) B6 645 0385

2 GOLF SPORTS BAG

100% polyester. Split main compartment with 2-way zip. Front pocket. Side pocket with external mesh pouch. Shoe pocket with breather holes. Padded, removable shoulder strap, adjustable in length. By COBRA for Mercedes-Benz.

Dimensions approx. 50x30x27 cm.

White/fuchsia/black B6 645 0389

Black (not shown) B6 645 0388



3

3 GOLF SHOE BAG

Black. 100% polyester. Large main compartment with subcompartments. 2-way zipper. Wrist loop. Ventilation holes. By COBRA for Mercedes-Benz. Dimensions approx. 25x11x37 cm. B6 645 0390

4 GOLF STAND BAG

Black. 100% polyester. 14 club divisions. Various pockets and pouches. Towel clip. Shoulder carrier with quick-release fastener. EasyFlex base for maximum ground contact. Detachable rain hood. By COBRA for Mercedes-Benz. Weight approx. 2.1 kg. Dimensions approx. 34x37x87 cm. B6 645 0387



4

5 GOLF BALLS, SET OF 3¹

White. Urethane. High Repulsion Core construction. For more length and control. By Bridgestone for Mercedes-Benz. B6 645 0394



6 GOLF CLUB HEADCOVER

Black. 100% polyester. Drawstring on back. Water-repellent and dirt-repellent. By COBRA for Mercedes-Benz. Dimensions approx. 15 x 15 x 34 cm. B6 645 0391

7 GOLF UMBRELLA

Black. Water and dirt-repellent canopy with UV protection. Shaft and ribs in fibreglass. Totally metal-free. Windproof. Diameter when open approx. 130 cm. B6 695 2633



¹ Available from May 2019.



1

1 CHILDREN'S BALANCE BIKE

Aluminium frame. 12-inch "Schwalbe Big Apple" tyres. Safety grips. Saddle height adjustable (approx. 41-47 cm). For heights of approx. 85 cm and over. Age 3+. Weight approx. 3.7 kg.

Purple B6 645 0081

Green (not shown) B6 645 0080

White/AMG (not shown) B6 645 0127

2 CHILDREN'S BIKE

Aluminium frame. 16-inch "Schwalbe Big Apple" tyres. Backpedal brake at rear. V-brake at front. Single-speed. Robust metal mudguards. Soft handlebar grips and stem with impact protection. Kick stand. Adjustable seat height (approx. 50-59 cm). Suitable for heights of approx. 105 cm and above, age 4+. Weight approx. 9.5 kg.

South Seas blue B6 645 0065

Pink (not shown) B6 645 0067



2

3 CHILDREN'S BIKE

Aluminium frame. 16-inch Schwalbe "BIG APPLE" tyres. Backpedal brake at rear. V-brake at front. Single speed. Robust metal mudguards. Soft handlebar grips and stem with impact protection. Kick stand. Adjustable seat height (approx. 50-59 cm). Suitable for heights upwards of approx. 105 cm, age 4+. Weight approx. 9.5 kg. B6 645 0148



3

4 SCOOTER

Black. Aluminium. Fully collapsible. Rubber-coated, folding handles. Suspension fork. Handlebars adjustable in height. 200 mm rollers with ABEC 9 ball bearings. Foot brake. Kick stand. Age 12+. Maximum load approx. 100 kg. Weight approx. 6.5 kg. Dimensions when folded approx. 86x35x12 cm. Foot length on running board approx. 34 cm. B6 695 5043



4



5 KID'S BIKE

Aluminium frame. 20-inch "Schwalbe Big Apple" tyres. Shimano 7-speed derailleurs. V-brakes. Robust metal mudguards. Aluminium stand. Saddle adjustable in height (approx. 60–73 cm). Age 6+, or height upwards of approx. 120 cm. Weight approx. 12.5 kg. Frame height 28 cm.

Green B6 645 0082

Purple (not shown) B6 645 0084

White/AMG (not shown) B6 645 0083

6 KID'S BIKE

Aluminium frame. Shimano 21-speed derailleurs. V-brakes. 24-inch "Schwalbe Big Apple" tyres. Robust metal mudguards. Saddle adjustable in height (approx. 67–80 cm). Age 8+, or height upwards of approx. 131 cm. Frame height approx. 31 cm. Weight approx. 12 kg.

Black B6 645 0155

White/AMG (not shown) B6 645 0156

White/purple (not shown) B6 645 0157



7 CRATER LAKE FITNESS BIKE

Black. Exclusive design with aluminium frame, 27 gears, suspension fork, disc brakes and 28-inch wheels. Weighs approx. 13.5 kg. Load capacity of up to approx. 100 kg. By FOCUS for Mercedes-Benz. Made in Germany.

B6 645 0108, -0109, -0192, -0111

8 SPORT SUNGLASSES

Black/blue plastic frame. Transparent/grey lenses. Lens shade adapts to light conditions. 100% UV-A/UV-B protection (UV-400). Filter category 1–3. Anti-reflective coating. B6 695 3504

FRAME	aluminium
FORK	SR Suntour NEX HLO, 63 mm, lockout
WHEELSET	Concept
TYRES	Schwalbe Smart Sam (Crater Lake) Schwalbe Citizen Light 42-622 (Aventura)
CHAIN RINGS	Shimano Alivio
CRANK SET	Shimano Acera
GEAR RATIO	front: 48/36/26, rear: 11–34
SHIFTER	Shimano Acera
REAR DERAILLEUR	Shimano Deore, 9-speed
FRONT DERAILLEUR	Shimano Acera
BRAKES	Tektro HD-M285, 160 mm/160 mm hydraulic disc brake
STEM/HANDLEBARS	Concept
EXTRAS FOR AVENTURA	
MUDGUARD/REAR CARRIER	Büchel Sport/Carrier Sport
SADDLE/SEAT POST	Concept Cross/Concept, 31.6 mm
FRONT LIGHT	Basta Echo 15, with switch
REAR LIGHT	Herrmans H-TRACE



For choice of size and geometry, see p. 108.



GIRLS' T-SHIRT

Off-white/red. 100% cotton. Short sleeves. Boat neck. Patterned neck tape. Modern fit. Reversible sequins with red heart and Mercedes star. Sizes 116/122-152/158. B6 695 4296-4299

REVERSIBLE BEAR/G-CLASS

See p. 51

BOYS' T-SHIRT

Light blue. 100% cotton. Short sleeves. Crew neck with blue ribbed cuffs. Patterned neck tape. Robots print on front. Modern fit. Silver-grey Mercedes star on left sleeve. Sizes 116/122-152/158. B6 695 4460-4463

BOYS' NECK POUCH

See p. 48

BOYS' BOARDSHORTS

Blue. 100% polyester. Zipped side pockets. Elastic waistband with part drawstring and cord. Embroidered badge with Mercedes-Benz star in silver grey on the bottom of the left leg. Sizes 116/122-152/158. B6 695 4515-4518

GIRLS' RUCKSACK, LARGE

See p. 48



Let's little ones enjoy a big success.

Should your offspring wear anything other than the best? We don't think so and have designed what looks good on kids and what they like: items of clothing that are as beautiful as they are robust, colourful bags and rucksacks as well as exclusive toys. This means even little ones can enjoy a big success.

THE MERCEDES-BENZ COLLECTION

1 NECK POUCH

Polyester. Illuminated Mercedes-Benz robots. Key ring. Transparent pane at the rear. Cord with child-protection mechanism. Mercedes star embroidered on front. Lining with Mercedes-Benz proprietary pattern. By Lässig for Mercedes-Benz. Dimensions approx. 12x0.5x13 cm.

Boys. Black/blue B6 695 4038
Girls. Black/pink B6 695 4039



2 LARGE RUCKSACK

Polyester. Water-repellent. Insulated front pouch. Two small zipped compartments. Transparent field for identity card. Padded shoulder straps. Illuminated Mercedes-Benz robots. Mercedes star embroidered on front. Lining with Mercedes-Benz proprietary pattern. By Lässig for Mercedes-Benz. Dimensions approx. 32x18x42 cm.

Girls. Black/pink B6 695 5768
Boys. Black/blue B6 695 5767

3 SMALL RUCKSACK

Polyester. Water-repellent. Large main compartment. Separate compartment for cooling block. Small extra pocket on the front. Net pocket on the outside for drinks bottle. Transparent pane for identity card. Padded, adjustable shoulder strap. Chest strap. Illuminated Mercedes-Benz robots. Mercedes star embroidered on front. Lining with Mercedes-Benz proprietary pattern. By Lässig for Mercedes-Benz. Dimensions approx. 24.5x15.5x27 cm.

Girls. Black/pink B6 695 5770
Boys. Black/blue B6 695 5769



4



4

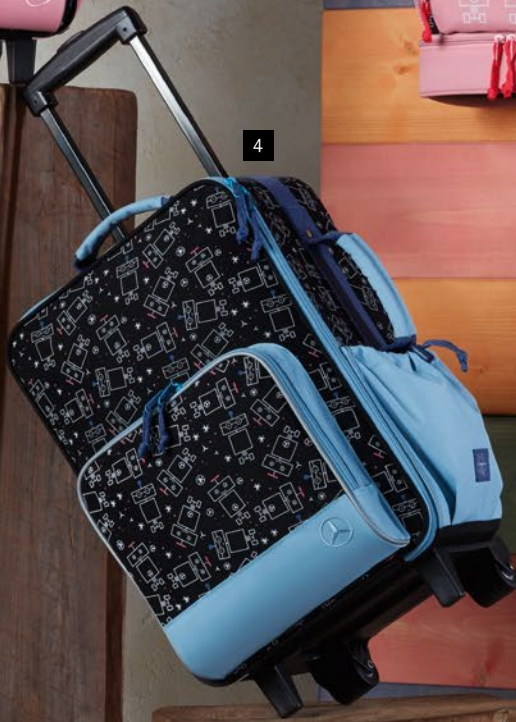

1



3



3

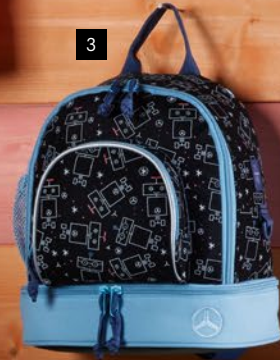

2



49

4 TROLLEY

Polyester. Water-repellent. Functional interior trim with packing straps. Various outside pockets. With practical shoe bag. Adjustable grip. Transparent field for identity card. Illuminated Mercedes-Benz robots. Mercedes star embroidered on front. Lining and shoe bag with Mercedes-Benz proprietary pattern. By Lässig for Mercedes-Benz. Dimensions approx. 29.5 x 19.5 x 46 cm.

Girls. Black/pink B6 695 5201

Boys. Black/blue B6 695 5202



1 CARL KEY RING

Beige. Polyester plush. Flat split ring. Stitched-on woven label featuring Mercedes star. Dimensions approx. 12x4x6 cm. B6 695 3238

2 CARL HOT-WATER BOTTLE

Beige/cream. Rubber/polyester plush. Case washable at 30°C. 3D star stud in ear. Stitched-in fly label featuring Mercedes star. Dimensions approx. 22x12x50 cm. B6 695 3692

3 CARL BELT PAD

Cream/beige. Polyester plush. Longitudinal continuous Velcro fastener on the rear. Washable at 30°C. Sewn-on bear application. Stitched-in woven label featuring Mercedes star. Dimensions approx. 9x4x20 cm. B6 695 3693



1-2



3



50

4 CARL HOODED TOWEL

Cream/beige. 95% cotton/5% polyester. OEKO-TEX® Standard 100. Washable at 60°C. Suitable for tumble drying. Stitched-in woven label featuring Mercedes star. Dimensions approx. 100x100 cm. B6 695 3691

5 CARL CHILDREN'S BLANKET WITH CUSHION FUNCTION

Beige. Polyester plush. Can be used as a cushion when folded up. Blanket can be stored in the cushion part. Dimensions of blanket approx. 100x120 cm. Dimensions of cushion approx. 38x12x30 cm. B6 695 3260

6 CARL COMFORT BLANKET

Beige. Polyester plush. Size approx. 30x7x33 cm. B6 695 3259



7



8



9



10

7 DUMMY

Plastic/silicone. Orthodontic silicone dummy. With grab ring. Protective cap and storage box. Made in Germany. Size 1 (from 0 months).

Purple/yellow B6 695 3250

Green/yellow (not shown)
B6 695 3249

8 CHILDREN'S SUNGLASSES

Plastic frames. Soft, ultra-flexible side arms. Grey lenses by Carl Zeiss Vision. 100% UV-A-/UV-B protection (UV-400). Filter category 3.

Purple/grey B6 695 3502

Green/yellow (not shown)
B6 695 3503

9 PLUSH SLIPPERS

Red. Polyester plush. G-Class design. Anti-slip soles. Embroidered radiator grille and headlamp details. Woven Mercedes star label.

Shoe size 28-33 B6 695 3257

Shoe size 34-39 B6 695 3258

10 REVERSIBLE BEAR/G-CLASS

Beige/red. Polyester plush. Zip on back of bear/base of car for changing between bear and G-Class. Size approx. 35 cm.

B6 695 2860

11 CHILDREN'S SUITCASE

Red/black. Polypropylene. Practical organisation features inside with elasticated packing straps in lower compartment and divider in upper compartment. Wheels. Extendable pulling strap and pulling bar. Lid locked by means of two side latches. Dimensions approx. 48 x 24 x 20 cm.

B6 695 4102



11

MEN'S LEATHER JACKET

See p. 54

MEN'S WINDSTOPPER PULLOVER

See p. 61

MEN'S CLASSIC AUTOMATIC WRISTWATCH¹

Bronze case with stainless steel back. Brown dial. Bronze-coloured hand. Anti-reflective sapphire glass on both sides. Brown leather strap. Water-resistant to 5 ATM. Diameter 42 mm. Sellita SW 200 automatic movement. Swiss made. B6 604 1677

¹ Available from April 2019.



Your design story begins now.

The exclusive Mercedes-Benz Classic Collection finds legendary style icons from the unique Mercedes-Benz history. It takes up the timeless, stylistic line and impresses with the unique Mercedes-Benz craftsmanship. Classic cuts and high-quality materials create its own series in which every collector's item fits perfectly to the other.



SCAN THE QR CODE AND EXPERIENCE THE COLLECTION.

http://mb4.me/MBA_Classic_Collection

THE MERCEDES-BENZ CLASSIC COLLECTION

Heinz Bauer Manufakt.



1

In 1960, Heinz and Margot Bauer established the traditional Swabian company called Heinz Bauer Manufakt. At an early stage, the couple started producing their own jacket collection with great success. Today, Jochen Bauer is the second generation at the helm of the company. With time, the company developed a great collection and international reputation with innovative details, rooted in a passion for driving convertibles.

54



1 MEN'S LEATHER JACKET

Brown. Outer material 100% cowhide, lining 51% cotton/49% viscose. Removable collar with zip. Robust shoulder and sleeve padding. Smocked sections on cuffs and seam. Perforated sections on front section, back section and sleeves. Modern fit. By Heinz Bauer Manufakt for Mercedes-Benz. Sizes 48-56. B6 604 1631-1635



USE THE WALLET FUNCTION OF YOUR SMARTPHONE

Simply scan the QR code and you will have the opportunity to clearly store the high-quality personal accessories from the Mercedes-Benz Collection on your mobile phone. Once stored, you are always up to date, wherever you are.

2



3



55

2 CAP

Dark brown. Outer material 100% cowhide, lining 51% cotton/49% viscose. Folding draft stop. Refined quilting on front section. Perforated leather under sign. Eyelets for optimum air circulation. By Heinz Bauer Manufaktur for Mercedes-Benz. Sizes 55-59. B6 604 8052-8056

3 MEN'S LEATHER GLOVES

Brown. 100% cowhide. Perforated and quilted inserts. Leather band can be adjusted in width featuring press studs. By Heinz Bauer Manufaktur for Mercedes-Benz. Sizes 8, 8.5, 9, 9.5. B6 604 1666-1669

1 300 SL SHIFT LEVER KNOB GUEST UMBRELLA

Brown. 100% polyester canopy with water- and dirt-repellent coating. Steel shaft, fibreglass ribs. Windproof. Diameter when open approx. 130 cm. B6 604 3226



2 RUCKSACK¹

Dark brown. Cowhide. Various compartments. Breathable rear face with strap including safety pocket with zipper for securing onto the trolley handle. Carrying handle. Padded, breathable and adjustable shoulder carrier. Detachable address tag. By Bric's for Mercedes-Benz. Dimensions approx. 30x18x43 cm. B6 604 2013

3 BUSINESS BAG¹

Dark brown. Cowhide. Various inside and side compartments. Identity tag. Removable shoulder strap. Mercedes-Benz Classic embossing on inside and outside. By Bric's for Mercedes-Benz. Dimensions approx. 38x7x28 cm. B6 604 2012

4 WEEKEND BAG¹

Dark brown. Cowhide. Various pockets. Straps on back section for attachment to the trolley suitcase. Shoulder straps. Reinforced base. Feet in base. Mercedes-Benz Classic embossing on inside and outside. By Bric's for Mercedes-Benz. Dimensions approx. 55x20x32 cm. B6 604 2011



2-4



5



6

5 WALLET¹

Dark brown. Cowhide. Twofold bank note compartment. Loose change compartment. Various card slots. Folding, transparent ID pocket. RFID protection. By Bric's for Mercedes-Benz. Dimensions approx. 12.5x9.5 cm. B6 604 2014

6 TROLLEY WITH 4 ROLLERS¹

Beige / dark brown. Polycarbonate Makrolon® / cowhide. Two inner compartments. Pull-out handle with three fixed positions. Double rollers with rubber coating. Integrated TSA lock. Identity tag. Mercedes-Benz Classic embossing on inside and outside. By Bric's for Mercedes-Benz. Dimensions approx. 38x20x50 cm. B6 604 2015

All products on this page



¹ Available from May 2019.



1-2

1 COVER

Brown. Aluminium/polycarbonate/polyurethane. Protects the casing against scratches. Mercedes "Vintage star" logo.

iPhone® X/iPhone® XS
B6 604 2018

Samsung Galaxy S9 (not shown)
B6 604 2019

2 COVER

Multicoloured. Acrylic/polycarbonate. Protects the casing against scratches. Retro print with racing car motif. Vintage "Mercedes" lettering on the inside.

iPhone® X/iPhone® XS
Suitable for wireless charging.
B6 604 2020

Samsung Galaxy S9 (not shown)
B6 604 2021

3 KEYCHAIN

Stainless steel. Flat keyring with 3 smaller split rings for quick removal/replacement of individual keys. Length approx. 11 cm.

Gold-coloured/blue B6 604 1518
Silver-coloured/blue (not shown)
B6 604 1675

4 STUTTGART KEY RING

Silver-coloured. Stainless steel. Flat split ring with three additional mini split rings for quick removal/replacement of individual keys. Made in Germany. Length approx. 9 cm. B6 604 1524



3



4



5



6

5 BALLPEN

Metal barrel. Twist-action. Mercedes star on top of cap.

Red/silver-coloured
B6 604 3351

Black/silver-coloured (not shown)
B6 604 3350

Silver-coloured (not shown)
B6 604 3352

6 CRYSTAL BALLPOINT PEN

Rose gold colours. Brass/glass. Swarovski® Crystal Fine Rocks on barrel. Twist cap. Writes in blue. Vintage logo lasered on the top side. Made for Mercedes-Benz by Swarovski®. B6 604 1612

7 300 SL COMPUTER MOUSE

Red. Wireless. In form of 300 SL. LED headlamps and tail lights with On/Off switch. 2.4 GHz wireless technology. USB nano receiver. High-resolution optical sensor with switchable sensitivity (between 800 dpi and 1600 dpi). Compatible with all standard operating systems. B6 604 1625



7



8

8 MEN'S JACKET

Black. Outer material 60% cotton/40% polyester, quilted taffeta lining 100% polyester. Wind- and water-repellent. 2-way front zip closing. Stand-up collar with catch and 2 press stud fasteners. Various pockets. Sleeve end with zipper. Shoulder and elbow area quilted and slightly padded. Modern fit. "Vintage star" metal badge in the chest area, embossed "Mercedes" lettering on the back, embossed vintage laurel leaves on sleeves. Sizes: S-XXL. B6 604 1646-1650

9

9 MEN'S T-SHIRT

Black. 100% cotton. Crew neck. Racing car retro print on the front. Vintage laurel leaf print on the sleeves. Woven neckband with checked design. Slim fit. Vintage star on front. Vintage "Mercedes" lettering on the back section. Sizes: S-XXL. B6 604 1670-1674

10 SINDELINGEN KEY RING

Gold-plated brass. Flat split ring with three mini split rings for quick removal/replacement of individual keys. Made in Germany. Length approx. 9 cm. B6 604 1523

11

11 MEN'S CHRONOGRAPH, CLASSIC RALLEY

Square stainless steel case. Black and beige dial with bordeaux red outline. Steel-coloured hands with Super-LumiNova® detail, bordeaux red second hand. Anti-reflective sapphire glass on both sides. Black calfskin strap with perforation and red lining. Water-resistant to 5 ATM. Dimensions 40 x 40 mm. Ronda Z60 quartz movement. Swiss made. B6 604 1679

12

12 COVER

Black/white/red. Acrylic/polycarbonate. Protects the casing against scratches. Mercedes "Vintage star" logo.

iPhone® X/iPhone® XS Suitable for wireless charging. B6 604 2016

Samsung Galaxy S9 (not shown) B6 604 2017



1-4

1 MEN'S JACKET

Navy. Outer material 46% cotton/36% polyester/18% polyamide, split inner lining: Woven chequered at top: 100% cotton, quilted lining below: 100% polyester with lightweight padding. Wind- and water-repellent. High-closing collar. Pleats. 2-way zipper. Stand-up collar with catch and press stud fastener. 4 attached pockets. Side latch with press stud fastener for adjustment of the waist size. Modern fit. A matching gilet (B6 604 1656-B6 604 1660) attachable into the jacket with press studs can be purchased separately. Sizes: S-XXL. B6 604 1636-1640

2 MEN'S GILET

Navy. Outer material and lining: 100% polyamide. Wadding: 100% polyester. Extra high collar. Elastic side rib sections. Zipped pocket inside. Buttoned in men's jacket (B6 604 1636-1640). Modern fit. Sizes: S-XXL. B6 604 1656-1660

3 LADIES' JACKET

Black. Outer material 46% cotton/36% polyester/18% polyamide, split inner lining: Woven chequered at top: 100% cotton, quilted lining below: 100% polyester with lightweight padding. Wind- and water-repellent. High-closing collar. Pleats. 2-way zipper. Stand-up collar with catch and press stud fastener. 4 attached pockets. Belt for adjustment of waist size. Modern fit. A matching gilet (B6 604 1651-B6 604 1655) attachable into the jacket with press studs can be purchased separately. Sizes XS-XL. B6 604 1641-1645

4 WOMEN'S GILET

Black. Outer material and lining: 100% polyamide. Wadding: 100% polyester. Extra high collar. Elastic side rib sections. Zipped pocket inside. Modern fit. Buttoned in women's jacket (B6 604 1641-B6 604 1645). Sizes XS-XL. B6 604 1651-1655

60



5



7



6



8

5 FLAT CAP

Brown/beige. Polyester. Herringbone design. One size. B6 604 1503

6 CAP

Black. 100% cotton. Vintage star embroidered on front, trimmed with Swarovski® crystals. Embroidered vintage "Mercedes" lettering on left side in gold. Metal clasp for adjusting fit. B6 604 1517

7 CAP

Navy with off-white contrasts. 100% cotton. Strap with metal clasp, embossed with star logo, for adjusting fit. B6 604 1540

8 300 SL CUFF LINKS

Bronze. Front with wave structure from the interior of the 300 SL, vintage Mercedes-Benz logo on the back. Diameter approx. 1.5 cm. B6 604 3326



9-10

9 MEN'S POLO SHIRT

Black. 95% cotton/5% elastane. Button band. Collar and cuffs in single rib. Slim Fit. 1926 classic logo badge on front section. Sizes S-XXL. B6 604 1597-1601

10 MEN'S POLO SHIRT

Navy. Neck tape and inside of collar in off-white. 100% cotton piqué. Sizes S-XXL. B6 604 1535-1539

11 MEN'S SHIRT

100% cotton. Single-rib cuffs. Classic 1926 logo overprinted on front and in nape. Sizes S-XXL.

Offwhite B6 604 1546-1550

Navy (not shown) B6 604 1551-1555

12 MEN'S POLO SHIRT

100% cotton. Contrasting neck band and side vent trim. Single-rib collar and cuffs. Button front. Modern fit. 1926 Classic logo badge and vintage Mercedes lettering embroidered on the back section in high-gloss thread. Sizes S-XXL.

Black B6 604 1592-1596

Bordeaux (not shown) B6 604 1587-1591

13 LADIES' POLO SHIRT

Navy. Contrasting neck tape and side vent trim. 100% cotton. Short sleeves. Single-rib collar and cuffs. Button band. Modern fit. 1926 classic logo badge and vintage Mercedes lettering embroidered on the back section in high-gloss thread. Sizes XS-XL. B6 604 1582-1586

14 LADIES' POLO SHIRT

95% cotton/5% elastane. Vintage Mercedes star, adorned with Swarovski® crystals on front. Gold-coloured "Mercedes" lettering on right sleeve. Sizes XS-XL.

Black/gold-coloured B6 604 1510-1514

Red/gold-coloured (not shown) B6 604 1602-1606



11



12



13-14

15 MEN'S WINDSTOPPER PULLOVER

Navy / cognac. Outer material 45% polyamide / 35% merino wool/20% cotton. Lining 100% polyester. Windproof. Breathable. High-closing rib collar. Front, rear and sleeves knitted in a mix of patterns. Sleeves and hem rounded off with single-rib. Applications in suede look. "Historic star" badge on the sleeve. Knitted, tonal "Mercedes-Benz" lettering on back. Sizes: S-XXL. B6 604 1661-1665



15



1

1 COMPACT UMBRELLA²

Dark brown. Canopy 100% polyester. Aluminium frame. Fibreglass/aluminium rails. Hook handle with genuine leather trim. Automatic opening and closing. Windproof design. Fastening tab with Velcro fastener. Matching case with zipper. Diameter when open approx. 103 cm. Length approx. 35 cm. B6 604 1681



2

2 MEN'S CHRONOGRAPH WATCH, CLASSIC 300 SL

Stainless steel case with red colour outlay on front side of pushpiece. Beige-metallic dial with red and brown accents, simulated wave structure in the counter eyes and 300 SL emblem. Brown calfskin strap with red seam and perforated design. Steel-coloured hands. Stopwatch function. Water-resistant to 10 ATM. Diameter approx. 44 mm. Ronda 5021.D Swiss quartz movement. Swiss made. B6 604 1615

62

3 WOMEN'S CLASSIC LADY ROMAN WATCH

Stainless steel case with gold-coloured PVD coating. Silver-coloured dial with gold-coloured Roman numerals and hour markers. Gold-coloured hands. Stainless steel Milanese mesh strap with gold-coloured PVD coating. Water-resistant to 5 ATM. Diameter 34 mm. Ronda 773 quartz movement. Swiss movt. B6 604 1570



3

4 WOMEN'S WATCH, CLASSIC LADY SILVER

Stainless steel case. Silver-coloured dial with steel-coloured Roman numerals and hour markers. Silver-coloured hands. Stainless steel Milanese mesh strap. Water-resistant to 5 ATM. Diameter 34 mm. Ronda 773 quartz movement. Swiss movt. B6 604 1621



4

5 MEN'S CLASSIC RETRO GOLD CHRONO-

GRAPH WATCH Stainless steel case with rose gold-coloured PVD coating. Silver-coloured dial with hours and minutes, Super-LumiNova® luminous dots and three-dimensional cap structure in centre. Leather strap with crocodile effect. Rose gold-coloured luminous hands. Stopwatch function. Water-resistant to 5 ATM. Diameter approx. 42 mm. Ronda 5030 Swiss quartz movement. Swiss movt. B6 604 1617



5

6 300 SL DESK CLOCK

Silver-coloured. Aluminium/stainless steel. In the shape of the 300 SL. Wave pattern on dial. Dimensions approx. 20x3.5x6 cm. B6 604 1613



6

¹ Available from April 2019.



7

7 NODDING DOG

Brown. Plastic with synthetic fur. Gold-coloured collar with brass Mercedes star logo tag. Made in Germany. Size: approx. 29 x 18 cm. B6 604 1451

8 WINE SET, 300 SL GEAR KNOB

Cream beige/silver-coloured. Wine stopper with wooden head in form of 300 SL gear knob. Stainless steel waiter corkscrew. In black gift box. Dimensions of packaging approx. 10.8 x 14.3 x 5.5 cm. B6 604 1565



8-9



10

9 WINE STOPPERS, SET OF 4

Various colours. Wood/stainless steel. Gear knob design. 3 wine stoppers with a wooden head, 1 champagne stopper with stainless steel head. In high-quality gift packaging. Dimensions of packaging approx. 21.5 x 15.5 x 5.5 cm. B6 604 5160

10 PICNIC HAMPER²

Dark brown. Poly rattan. Fasteners and carrying handles made from leather. Reinforced carry handles made from canvas. Content: 2 x cutlery set, 2 x porcelain dishes, 2 x coffee cups, 2 x juice glasses, 1 x pepper pot, 1 x salt pot, 2 x serviettes 40 x 40 cm, 1 x tablecloth 140 x 140 cm. Dimensions approx. 50 x 34 x 31 cm. B6 604 1562

11 SENATOR THERMAL FLASK, 1.0 L¹

Silver-coloured/dark brown. Stainless steel. Real leather gaiter. Double-walled. Keeps drinks cool for up to 24 hours and hot for up to 12 hours. 100% sealed. With integrated drinking cup. By esma for Mercedes-Benz. Diameter approx. 9 cm. Height approx. 30 cm. Capacity approx. 1.0 l. B6 604 5701

12 CLASSIC PICNIC BLANKET

Brown/ivory. Upper side made from soft polyester fleece, bottom made from water-repellent polyamide fabric. Pull strap with size-adjustable strap and carrying handle. By Fraas for Mercedes-Benz. Size: approx. 140 x 200 cm. B6 604 1563

13 CUDDLY BEAR

Beige. Polyester plush. By NICI for Mercedes-Benz. Size approx. 35 cm. B6 604 1559



11

emsa



12

FRAAS
THE GIFT COMPANY



13

NICI

² Available from May 2019.



MEN'S SOFTSHELL JACKET

Black / silver-grey. 100% polyester. Zipped and size-adjustable hood. Width-adjustable cuffs and with additional elastic cuffs, which can be pulled out if necessary. Ventilation studs in underarm area. Inner lining with two attached pockets. Sizes: S-XXL. B6 787 1263-1267

MEN'S T-SHIRT

Black / dark grey / white. 100% cotton. Crew neck. Modern fit. Tyre print and "Sprinter" lettering at the front. Tonal star logo embroidered on left sleeve. Sizes: S-XXL. B6 787 1257-1261

FOLDING CHAIR

Black. Tubular steel frame with hard-wearing polyester cover. Armrests with drinks holder. Mercedes-Benz lettering embroidered on back. Transport bag. Load capacity of up to 160 kg. Packing size approx. 17x97 cm. Weight approx. 4.5 kg. B6 787 1621

CAP

Black. 100% cotton. Adjustable fit. B6 787 1649

Form follows fun.

Whether you drive a Sprinter for work, privately use a Marco Polo or an X-Class accompanies you everywhere – the new Mercedes-Benz Van Collection offers fascinating products that inspire not only drivers, but also fans. Look forward to products in which functionality is at the fore, but the design also speaks for itself.



THE MERCEDES-BENZ VAN COLLECTION



1



2



3

1 DOCUMENT FOLDER

Black. Polyester/polyurethane. All-round zip fastening. Dimensions approx. 25 x 34 cm. B6 787 2008

2 CASE FOR iPhone® X/iPhone® XS

Black. 50% polyethylene/50% polyurethane. Protects the casing against scratches. Tyre profile imprint and white "Sprinter" lettering. Suitable for NFC stickers and wireless charging. B6 787 2460

3 LAMY LOGO BALLPEN

Mountain grey/silver-coloured. Plastic/stainless steel. Push-action. Blue ink. Takes LAMY M 16 large-capacity refills. Silver-coloured Mercedes-Benz logo print on barrel. In decorative test tube packaging. By LAMY for Mercedes-Benz. Made in Germany.

Sprinter logo overprint on shank B6 787 2039

Vito logo overprint on shank B6 787 2040

Citan logo overprint on shank B6 787 2041



4

FRAAS
THE SCARF COMPANY



5

ANSMANN

4 REVERSIBLE FLEECE BLANKET

Black/anthracite. 100% polyester fleece. Mercedes star embossed on front. Size approx. 150 x 200 cm. B6 787 1618

5 LED TORCH, SMALL

Black. Aluminium. 80 lumen. Run-time of approx. 10 hours. Beam range of up to 150 m. Length approx. 16 cm. B6 695 3318



6

zippo



7

VICTORINOX

6 ZIPPO® LIGHTER

Black. Brass. By Zippo® for Mercedes-Benz. Made in USA. Dimensions approx. 3.9 x 1.5 x 5.8 cm. B6 695 3357

7 VICTORINOX SWISS CHAMP PENKNIFE

Black. Stainless steel/plastic. Officer's knife with 33 tools. By Victorinox for Mercedes-Benz. Length approx. 9.1 cm. Weighs approx. 185 g. B6 695 3410

8 SLEEPING BAG

Black/beige. Outer and inner material 100% nylon, filling in polyester. Mummy-style sleeping bag. All-round zip fastening. Opens fully for use as a quilt. Temperature range +13°C to -3°C. Suitable for height of up to 185 cm. By Deuter for Mercedes-Benz. Size approx. 205x75x48 cm. Weighs approx. 600 g. Packaging dimensions approx. 10x16 cm. B6 787 1197



8

9

10

11

12

67

VICTORINOX

VICTORINOX

9 WASH BAG

Black/beige. Polyester. With hanger accessory. Various pouches and mesh pockets. Removable mirror. Clip fastener. Dimensions approx. 50x30 cm. B6 787 1199

10 VICTORINOX MULTIFUNCTION TOOL

Silver-coloured. Stainless steel. 28 tools. Star logo etched on handle. Black leather pouch with belt loop. By Victorinox for Mercedes-Benz. Swiss made. Size with pouch approx. 4 x 12 x 3.5 cm. B6 695 3417

11 LED TORCH, LARGE

Black. Aluminium. 260 lumen. Run-time of approx. 50 hours. Beam range of up to 160 m. Focus control. Length approx. 32 cm. B6 695 3317

12 VICTORINOX CLIMBER SWISS ARMY KNIFE

Black. Stainless steel/plastic. Large and small blade, scissors, multipurpose hook, bottle opener, can opener, reamer, punch and sewing awl, corkscrew, ring and tweezers. By Victorinox for Mercedes-Benz. Length approx. 9.1 cm. B6 695 3409





1

1 RWANDA FLEECE

Black/anthracite. Polyester. Mercedes star logo on front. By Fraas for Mercedes-Benz.
Dimensions approx. 150 x 160 cm. B6 695 3627

2 PICNIC BLANKET¹

Khaki/sand beige. Upper side made from soft polyester fleece, bottom made from water-repellent polyamide fabric. Pull strap with size-adjustable strap and carrying handle. Storage bag with logo print.
By Fraas for Mercedes-Benz. B6 695 4747

3 BEACH UMBRELLA

Black/beige. 100% polyester. Fibreglass rails and lockable fibreglass lower shaft.
Waterproof. UV 50+ protection. Windproof design. Opened manually. Space-saving travel size.
Diameter approx. 147 cm. Length when closed approx. 71 cm. B6 695 4748



2



3

¹ Available from April 2019.



4



5



6



7

4 MEN'S T-SHIRT

Black. 100% cotton. Crew neck. Modern fit. Mercedes star logo on sleeve. Silhouette of the X-Class as reflective print on front section. Sizes: S-XXL. B6 787 1269-1273

5 USB FLASH DRIVE

White/grey/black. PVC. In the form of the Mercedes-Benz X-Class in 2D. 32 GB. USB 3.0 interface. Compatible with all standard operating systems. Dimensions approx. 6 x 3.5 x 0.9 cm. B6 787 1275

6 GRILL BRANDING IRON²

Silver-coloured. Stainless steel/beechwood/leather. Mercedes star logo as branding image. Mercedes-Benz lettering burned into the wooden handle. Grip length approx. 40 cm. Diameter of branding image approx. 10 cm. B6 695 4736

ICE-CUBE MOULD X-CLASS (NOT SHOWN)²

Black. Silicone. Raised tonal Mercedes star on top silicone section. Dimensions approx. 23 x 16 x 2 cm. B6 695 4746



8

7 FLIP*FLOPS, X-CLASS

Black. Plastic. EVA granule sole. X-Class laser print on outer sole, X-Class punched onto the sole underside. Toe strap with raised Mercedes star. Textile bag with logo print for storage. Sizes S (37/38), M (39/40), L (41/42), XL (44/45). B6 695 5183-5186

8 RUBBER RING, X-CLASS²

Transparent/silver-coloured. PVC. Two grab handles. Diameter approx. 120 cm. B6 695 4739

² Available from May 2019.



MEN'S SOFTSHELL JACKET

Black/red. Outer material 100% polyester, inner material 100% polyester fleece. Removable, width- and size-adjustable hood. Cuffs with adjustable Velcro fastening. Metal underarm ventilation eyelets. Various pockets. Width-adjustable waistband. High-closing front zip fastening with chin guard. Reflective print on hood, sleeves and back. Modern fit. Sizes: S-XXL. B6 787 1239-1244

MEN'S TRUCKS WRISTWATCH

See p. 72

TRAVEL BAG

Black. Polyester. Large inside compartment, shoe compartment on the side and inside pocket. 2-way zipper. Adjustable shoulder strap with anti-slip padding. Dimensions approx. 65 x 32.5 x 35 cm. B6 787 1669

MEN'S BELT

Black. Cowhide. Shortenable. Length approx. 140 cm. Width approx. 4 cm. B6 787 1635

480 KGS
200 LBS
300 KGS
70 LBS

KG.
LB.
M.
FT.

Made for doers.

Freedom, boundlessness and adventure – the Mercedes-Benz Trucks Collection is perfect for the roads of this world. Many products take up the design of the Actros radiator grille. Durable materials and cool cuts bring the Mercedes-Benz Trucks lifestyle to life. Feel free!

CAP

Black. Cotton/polyester mesh. Actros radiator grille print and Mercedes star embroidered on front section, Actros embroidered on back section. Adjustable fit. B6 787 1301



SCAN THE QR CODE AND EXPERIENCE THE COLLECTION.

http://mb4.me/MBA_Trucks_Collection

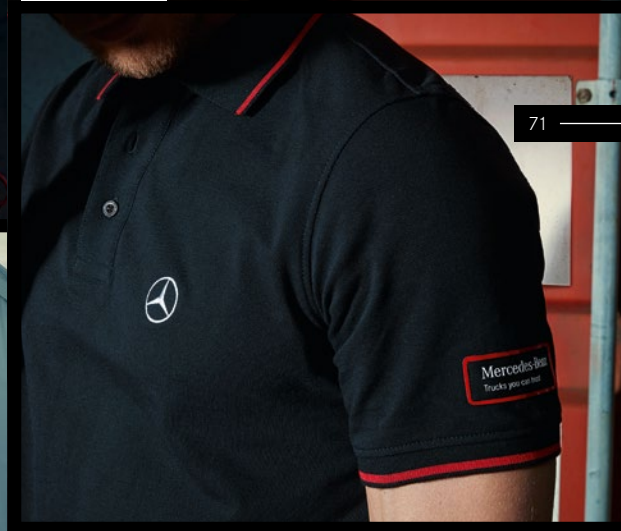

MEN'S POLO SHIRT

Black/red. 100% cotton. Single-rib collar and cuffs. Button band. Red woven stripes on the collar and cuffs. Band on side vents, Actros radiator grille elements imprinted on button band and in the neck. Modern fit. Sizes S-XXXL. B6 787 1245-1250



THE MERCEDES-BENZ TRUCKS COLLECTION

1 MEN'S TRUCKS WRISTWATCH

Stainless steel case with crown protection. Black dial with partially red digits. Hands with Super-LumiNova® detail. Hardened mineral crystal. Black silicone strap. Water-resistant to 10 ATM. Diameter 42 mm. Quartz movement. B6 787 1195

2 COVER FOR SAMSUNG GALAXY

Black. Polycarbonate/polyurethane. Protects the casing against scratches. Actros logo.

Samsung Galaxy S5 mini B6 787 2459

Samsung Galaxy S8 (not shown) B6 787 2092

3 DOCUMENT FOLDER

Black/red. Polyester/polyurethane. All-round zip fastening. Dimensions approx. 25x34 cm. B6 787 2007



1



2

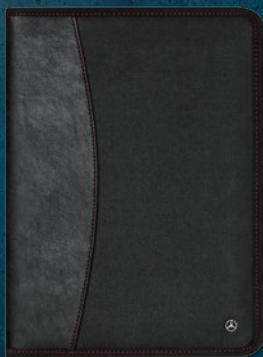

3



4

4 ACTROS KEYCHAIN

Black/silver-coloured. Die-cast zinc. Actros outline on the front, Actros lettering on the rear. Split ring with three additional mini split rings for quick removal/replacement of individual keys. Length approx. 9.5 cm. B6 695 3825

5 MOBILITY THERMAL FOOD CONTAINER, 1.2 L¹

Silver-coloured/black. Stainless steel. Double-walled. Keeps drinks cool for up to 12 h and hot for up to 6 h. 100% sealed. With integrated food compartment. Easy to clean. By esma for Mercedes-Benz. Dimensions approx. 17 x 15 x 17.3 cm. Capacity approx. 1.2 l. B6 787 2867

6 MOBILITY THERMAL FLASK, 1.0 L¹

Silver-coloured/black. Stainless steel. Double-walled. Keeps drinks cool for up to 24 hours and hot for up to 12 hours. 100% sealed. With insulated drinking cup. By esma for Mercedes-Benz. Diameter approx. 8 cm, height approx. 30 cm. Capacity approx. 1.0 l. B6 787 2866

7 THERMAL CUP, 0.36 L¹

Silver-coloured/black. Stainless steel. Double-walled. Keeps drinks cool for up to 8 h and hot for up to 4 h. Pushbutton opening. Drinking opening all points around 360 degrees. 100% sealed. Detachable sealing cap. Dishwasher safe. By esma for Mercedes-Benz. Diameter approx. 8.3 cm, height approx. 20 cm. Capacity approx. 0.36 l. B6 787 2874

8 THERMAL CUP, 0.5 L¹

Silver-coloured/black. Stainless steel. Double-walled. Keeps drinks cool for up to 12 h and hot for up to 6 h. Pushbutton opening. Drinking opening all points around 360 degrees. 100% sealed. Detachable sealing cap. Dishwasher safe. By esma for Mercedes-Benz. Diameter approx. 8.3 cm, height approx. 24 cm. Capacity approx. 0.5 l. B6 787 2875

¹ Available from April 2019.





1



2

1 KNITTED HAT

Black/white. 100% polyacrylic. With turnover fold. Actros lettering. B6 787 1437

2 MEN'S T-SHIRT

Black/silver-grey. 100% cotton. Reflective print. Modern fit. Actros vehicle silhouette on the front. Embroidered Mercedes star on left sleeve. Sizes: S-XXL. B6 787 1251-1256



3-4

3 MEN'S 2-IN-1 JACKET

Black/red. 100% polyester. Windbreaker with removable hood and cord to adapt the width. Quilted inner jacket with stand-up collar. Metal underarm ventilation eyelets. Reflective inserts on front and back. Reflective print on the hood, sleeves and back. Cuffs with adjustable Velcro fastening. High closing front zipper. Various pockets. Loose fit. Sizes S-XXXL. B6 787 1233-1238



5

5 CHILDREN'S CAP

Black/red. 100% polyester. Actros radiator grille and Mercedes star embroidered on front section, Actros embroidered on back section. Adjustable fit. B6 787 1303

4 MEN'S DRIVER'S BOMBER JACKET

Black/red. Outer material 100% polyester with PU coating, inner lining and padding: 100% polyester. Stand-up collar, waistband and cuffs made of ribbed material. Metal underarm ventilation eyelets. Reflective piping on front and back. Reflective print on back. High closing front zipper. Various pockets. Loose fit. "Mercedes-Benz Trucks you can trust" print on left chest, silver Mercedes star print on left upper arm. Sizes S-XXXL. B6 787 1227-1232



6 ZIPPO® LIGHTER

Matt chrome brass. Stylised, laser-engraved ACTROS front. By Zippo® for Mercedes-Benz. Made in USA. Dimensions approx. 4 x 6 x 1.5 cm. B6 787 2020

6



7

7 WASH BAG

Black/red. Polyester. Hanger accessory. Various pouches and mesh pockets. Removable mirror. Clip fastener. Dimensions approx. 50 x 30 cm. B6 787 1198

8 REVERSIBLE FLEECE BLANKET

Black/anthracite. 100% polyester. Surrounding border. Size approx. 150 x 200 cm. B6 787 2010

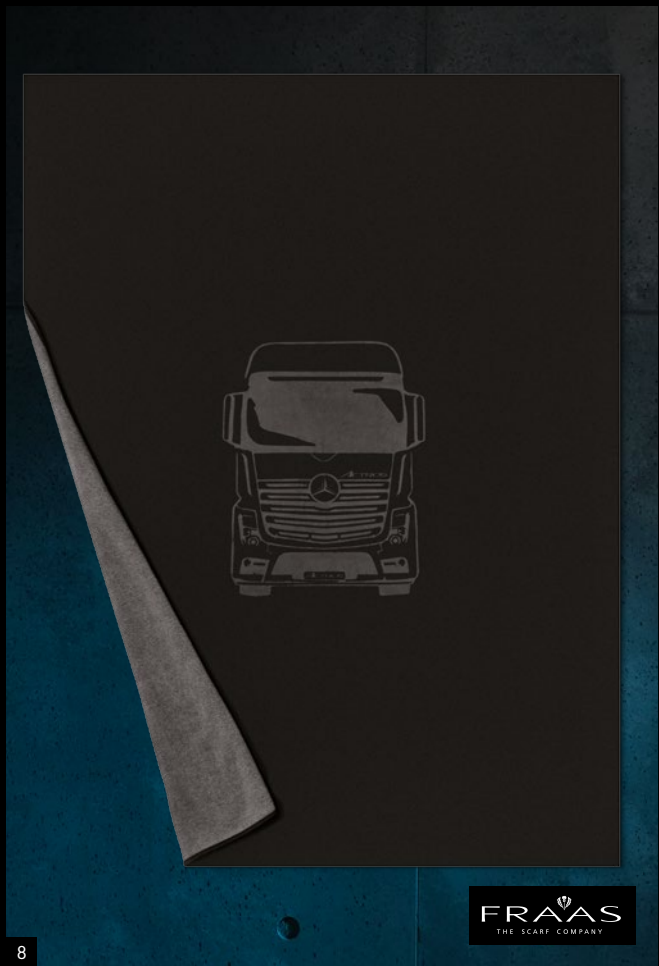

8

75



USE THE WALLET FUNCTION OF YOUR SMARTPHONE

Simply scan the QR code and you will have the opportunity to clearly store the high-quality personal accessories from the Mercedes-Benz Collection on your mobile phone. Once stored, you are always up to date, wherever you are.

MEN'S JACKET

Black. 87% polyester/13% elastane. Dual-Thermo-R for ideal temperature control. Stowable hood. Removable sleeves. Pocket on bottom front. Regular fit. By PUMA for Mercedes-Benz. Sizes: XS-XXL. B6 799 6335-6340

MEN'S AUTOMATIC CHRONOGRAPH, MOTORSPORTS

Stainless steel case with PVD coating. Black dial. Steel-coloured hour and minute hands, blue second hand, tips with Super-LumiNova® detail. Anti-reflective sapphire glass on both sides. Black leather strap. Water-resistant to 10 ATM. Diameter 43 mm. ETA 7750 automatic movement. Swiss made. B6 695 4398

MEN'S POLO SHIRT

100% cotton. Button front. Stripe print on sleeves. Neck band in contrasting colour. Regular fit. By PUMA for Mercedes-Benz. Sizes XS-XXL.

Indigo

B6 799 6353-6358

Black (not shown)

B6 799 6294-6299

MEN'S SWEATSHORTS

Black. 70% polyester/30% viscose. Textured double-knit material. Side pockets with zips. Regular bermuda fit. By PUMA for Mercedes-Benz. Sizes: XS-XXL.

B6 799 6364-6369



All products on this page



The stuff that legends are made of.

The Mercedes-Benz Silver Arrows are legendary. The associated Mercedes-Benz Motorsport Collection takes up the design and performance of the Formula cars and moves them from the race track onto the road. The design characterised by black and silver and the range influenced by high-tech materials radiate uncompromising sportiness.



THE MERCEDES-BENZ MOTORSPORTS COLLECTION



1-2



5

5 MEN'S POLO SHIRT

74% nylon/26% polyester. Optimum temperature control due to strategically positioned knitted structures. evoKnit technology. Zip fastening. "Slim but modified" fit. By PUMA for Mercedes-Benz. Sizes: XS-XXL.

Silver-coloured B6 799 6271-6276

Black (not shown) B6 799 6255-6260

All products on this page



3-4

1 MEN'S T-SHIRT

Black. 100% cotton. PUMA DryCELL technology. Neck band in contrasting colour. Regular fit. MERCEDES AMG PETRONAS MOTORSPORT logo print. MERCEDES AMG PETRONAS MOTORSPORT neck band. PUMA Cat logo on shoulder. By PUMA for Mercedes-Benz. Sizes: XS-XXL. B6 799 6225-6230

2 MEN'S T-SHIRT

Indigo blue. 100% cotton. Neck band in contrasting colour. Regular fit. Graphic print on front and rear section with MERCEDES AMG PETRONAS MOTORSPORT logo. PUMA Cat logo on shoulder. By PUMA for Mercedes-Benz. Sizes: XS-XXL. B6 799 6231-6236

3 MEN'S T-SHIRT

Black. 100% cotton. Neck band in contrasting colour. Valtteri Bottas graphic print on the front. Regular fit. MERCEDES AMG PETRONAS MOTORSPORT logo badge, PUMA Cat logo on the shoulder. By PUMA for Mercedes-Benz. Sizes: XS-XXL. B6 799 6243-6248

4 MEN'S T-SHIRT

Black. 100% cotton. Neck band in contrasting colour. Lewis Hamilton signature on front. Graphic print on back. Regular fit. MERCEDES AMG PETRONAS MOTORSPORT logo badge, PUMA Cat logo on the shoulder. By PUMA for Mercedes-Benz. Sizes: XS-XXL. B6 799 6237-6242



6 MEN'S SWEAT JACKET

70% polyester/30% viscose. Textured double-knit material. Hood can be adapted using cords. Side pockets with zips. Regular fit. By PUMA for Mercedes-Benz. Sizes: XS-XXL. B6 799 6316-6321



7 MEN'S SWEAT JACKET

70% polyester/30% viscose. Textured double-knit material. Hood can be adapted using cords. Side pockets with zips. Regular fit. By PUMA for Mercedes-Benz. Sizes: XS-XXL. B6 799 6285-6290



8 LIGHTWEIGHT MEN'S JACKET

Black. 100% nylon. Jacket can be stored in hood. Reflective stripes on sleeves. Ergonomic fit thanks to raglan style. Elastic cuffs and waistband. Regular fit. By PUMA for Mercedes-Benz. Sizes: XS-XXL. B6 799 6322-6327

9 MID LAYER, MEN'S

Black. 55% nylon/45% cotton. Optimum temperature control. evoKnit technology. Zip on the side. "Regular but modified" fit. By PUMA for Mercedes-Benz. Sizes: XS-XXL. B6 799 6341-6346





1



2



3-4



USE THE WALLET FUNCTION OF YOUR SMARTPHONE

Simply scan the QR code and you will have the opportunity to clearly store the high-quality personal accessories from the Mercedes-Benz Collection on your mobile phone. Once stored, you are always up to date, wherever you are.

1 LIGHTWEIGHT MEN'S JACKET

Black. 100% polyester. Zip fastening. Cuffs on sleeves and hip. Various pockets. MERCEDES AMG PETRONAS MOTORSPORT logo on front. Regular fit. Sizes XS-XXL. B6 799 6071-6076

2 MUG

Black. Ceramic. MERCEDES AMG PETRONAS MOTORSPORT logo on front. Three-coloured circle on bottom of mug. Capacity approx. 0.3 l. B6 799 5497

3 RUCKSACK

Black. 100% polyester/30% nylon. Various compartments. Three-coloured press stud on right carrying handle. MERCEDES AMG PETRONAS MOTORSPORT logo on front. Dimensions approx. 25x13x44 cm. B6 799 5499

4 SPORTS BAG

Black/Petronas green. 100% polyester/25% nylon. Large main pocket, small closable front pocket. Adjustable shoulder belt. Three-coloured press stud on the right-hand side. MERCEDES AMG PETRONAS MOTORSPORT logo print on front. Dimensions approx. 52x27x39 cm. B6 799 5498

5 MEN'S MOTORSPORT CHRONO SILVER CHRONOGRAPH WATCH

Stainless steel case with black PVD coating and pushpiece with blue outlay. Silver-coloured dial made from genuine carbon fibre, graduated design, with Super-LumiNova® luminous dots and blue accents. Textile strap made from nylon with underside in leather. Black luminous hands. Blue second hand. Stopwatch function. Water-resistant to 10 ATM. Diameter approx. 45 mm. Ronda 5030 Swiss quartz movement. Swiss movt. B6 799 5428

6 MEN'S MOTORSPORT CHRONO BLACK CHRONOGRAPH WATCH

Stainless steel case with black PVD coating and pushpiece with blue outlay. Black dial made from real carbon fibre, graduated design, with Super-LumiNova® luminous dots and blue accents. Stainless steel bracelet strap. Steel-coloured luminous hands. Blue second hand. Stopwatch function. Water-resistant to 10 ATM. Diameter approx. 45 mm. Ronda 5030 Swiss quartz movement. Swiss movt. B6 799 5426

7 MEN'S AUTOMATIC CHRONOGRAPH, MOTORSPORTS

Stainless steel case with PVD coating. Black dial. Steel-coloured hour and minute hands, blue second hand, tips with Super-LumiNova® detail. Anti-reflective sapphire glass on both sides. Black leather strap. Water-resistant to 10 ATM. Diameter 43 mm. ETA 7750 automatic movement. Swiss made. B6 695 4398



5-7

¹ Available from April 2019.

8 LADIES' T-SHIRT¹

White. 44% modal/42% cotton/14% nylon.
Three-coloured neck band. Three-coloured circle
on the right sleeve. MERCEDES AMG PETRONAS
MOTORSPORT logo print on front, "77" print on
front, Bottas "Seventy Seven" print on back.
Regular fit. Sizes XS-XL. B6 799 6205-6209

9 LADIES' T-SHIRT¹

White. 44% modal/42% cotton/14% nylon.
Three-coloured neck band. Three-coloured circle
on the right sleeve. MERCEDES AMG PETRONAS
MOTORSPORT logo print on front, "44" print on
front, Hamilton "Forty Four" print on back.
Regular fit. Sizes XS-XL. B6 799 6185-6189

MEN'S T-SHIRT (NOT SHOWN)¹

Black. 100% cotton. Tricoloured neck band.
Tricoloured circle at top of back panel. MERCEDES
AMG PETRONAS MOTORSPORT logo print on left
sleeve, "77" print on back, Bottas "Seventy Seven"
print on the front. Regular fit. Sizes: XS-XXL.
B6 799 6425-6430

MEN'S T-SHIRT (NOT SHOWN)¹

Black. 100% cotton. Tricoloured neck band.
Tricoloured circle at top of back panel. MERCEDES
AMG PETRONAS MOTORSPORT logo print on left
sleeve, "44" print on back, Hamilton "Forty Four"
print on the front. Regular fit. Sizes: XS-XXL.
B6 799 6374-6379



10 DRAWSTRING SPORTS BAG

Black. 100% polyester. Main compartment with
tunnel drawstring. With front compartment with
zipper fastening. MERCEDES AMG PETRONAS
MOTORSPORT logo on front. Dimensions approx.
48x28x32 cm. B6 799 6215



1-2

1 WOMEN'S POLO SHIRT, DRIVER¹

Black. 95% cotton/5% elastane. Striped strap on sides, on the back of the collar as well as on the button band. Slim fit. Sizes XXS-XL. B6 799 6525-6530

2 MEN'S POLO SHIRT, DRIVER¹

Black. 95% cotton/5% elastane. Striped strap on sides, on the back of the collar as well as on the button band. Slim fit. Sizes: XS-XXL. B6 799 6515-6520

3 CHILDREN'S DRIVER T-SHIRT²

95% cotton/5% elastane. Short sleeves. Striped band on sides and on the back of the collar. Mercedes-Benz logo print. Various sponsor logos. Regular fit. Sizes 92-164.

Black B6 799 6475-6481

White (not shown) B6 799 6605-6607

4 MEN'S DRIVER T-SHIRT²

95% cotton/5% elastane. Short sleeves. Striped band on sides and on the back of the collar. Mercedes-Benz logo print. Various sponsor logos. Regular fit. Sizes: XS-XXL.

Black B6 799 6435-6440

White (not shown) B6 799 6445-6448

5 WOMEN'S T-SHIRT, DRIVER²

95% cotton/5% elastane. Short sleeves. Striped strap on sides and on the back of the collar. Mercedes-Benz logo print. Various sponsor logos. Regular fit. Sizes XXS-XL.

Black B6 799 6535-6540

White (not shown) B6 799 6545-6550



3-5

MEN'S SHIRT, TEAM (NOT SHOWN)³

White. 80% cotton, 20% polyester. Official MERCEDES AMG PETRONAS MOTORSPORT team shirt for the 2019 Formula 1 season. Short sleeves. Button-down collar. Concealed button band. Breast pocket. Striped strap on sides and on the back of the collar. Regular fit. Mercedes-Benz embroidered logo, various sponsor logos. Sizes XS-XXL. B6 799 6505-6510

MEN'S PULLOVER, TEAM (NOT SHOWN)³

Grey. 100% cotton. Striped pattern on cuffs. Regular fit. Mercedes-Benz embroidered logo. Various sponsor logos. Sizes XS-XXL. B6 799 6575-6580



6

6 MEN'S SOFTSHELL JACKET, TEAM³

Black. 100% polyester. Water-repellent front zipper. Zipped side pockets with a carbon fibre print. Stripe detail on the back of the collar. Mercedes-Benz embroidered logo. Regular fit. Sizes XS-XXL. B6 799 6495-6500

¹ Available from April 2019.

² Available from March 2019.

³ Available from July 2019.



7



8

7 KNITTED HAT, TEAM

Grey. 100% cotton. Coloured stripes on the edge. Embroidered Mercedes-Benz logo on the front. Official MERCEDES AMG PETRONAS Motorsport team beanie for the 2018 Formula 1 season. B6 799 6125

8 MEN'S CAGOULE, TEAM³

Black. 100% polyester. Water-repellent front zipper. Zipped side pockets with a carbon fibre print. Adjustable cuffs. Width adjustment. Reflector details. Stowable hood. Regular fit. Sizes XS-XXL. B6 799 6565-6570



9-10

9 TEAM CAP¹

100% polyester. MERCEDES AMG PETRONAS MOTORSPORT logo on sides. Sandwich peak with lettering. Metal clasp for adjusting fit.

Black B6 799 6216

White (not shown) B6 799 6217

CHILDREN'S CAP, HAMILTON (NOT SHOWN)²

Black. 100% polyester. Mercedes star on front, MERCEDES AMG PETRONAS MOTORSPORT logo on side, sandwich peak with "Never Give Up" lettering. Metal fastener on back. B6 799 6251

10 HAMILTON FLAT BRIM CAP¹

Black. 100% polyester. With flat brim. Lewis Hamilton wings logo and MERCEDES AMG PETRONAS MOTORSPORT logo on back. GRAN TURISMO logo on the side. Monster Energy[®] logo on the underside of the brim. Embroidered "44". Plastic fastener on back.

Black B6 799 6249

White (not shown) B6 799 6250

HAMILTON CAP (NOT SHOWN)²

100% polyester. Lewis Hamilton wings logo and MERCEDES AMG PETRONAS MOTORSPORT logo on back. GRAN TURISMO logo on the side. Monster Energy[®] logo on the underside of the brim. Embroidered "44". Sandwich peak with "Powerful Beyond Measure" lettering. Plastic fastener.

Black B6 799 6218

White (not shown) B6 799 6219

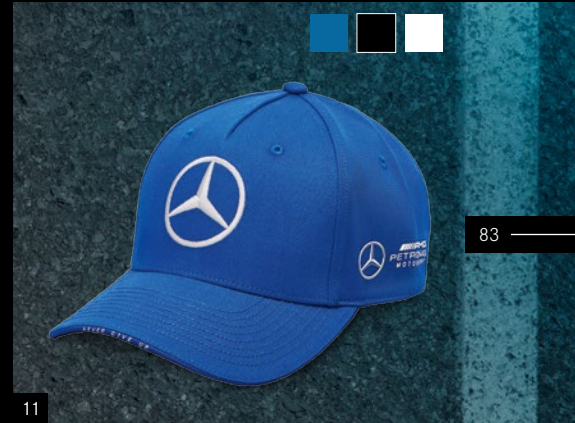

11

11 BOTTAS CAP¹

100% cotton. Valtteri Bottas logo on the back. MERCEDES AMG PETRONAS MOTORSPORT logo on sides. Monster Energy[®] logo on the underside of the brim. Metal clasp for adjusting fit.

Blue B6 799 6277

Black (not shown) B6 799 6278

White (not shown) B6 799 6279

WOMEN'S AMG CAP

White. Outer material 100% polyester.
Lining 100% cotton. Metal clasp for adjusting fit.
B6 695 2707

AMG LADIES' PERFORMANCE JACKET

Black/white. 100% polyester. Water and windproof.
Breathable. Openings on front and rear for additional
ventilation. Pertex® waterproofing. Dual-Protection-
System®. Size-adjustable hood. Width-adjustable
sleeves. Extended elastic cuffs with thumb hole.
Various pockets. Modern fit. White AMG 3D logo
print on chest, AMG logo print on the inside on the
back, white lining separation band featuring black
AMG logo, pocket with white AMG 3D logo print.
Sizes XS-XL.
B6 695 8651-8655

AMG LADIES' POLO SHIRT

See p. 86





SCAN THE QR CODE AND EXPERIENCE THE COLLECTION.

http://mb4.me/MBA_AMG_Collection



High-performance meets high-fashion.

Athletic. Provocative. Stylish. This Mercedes-AMG Collection is dedicated to those who live an urban lifestyle. The strong contrast of black and white, perforated fabrics, sporty cuts and high-quality materials exemplify a cool nonchalance. For all those who are confidently for a statement.

AMG C 63 S Cabriolet: Fuel consumption combined: 10.4 l/100 km, CO₂ emissions, combined: 236 g/km.



THE MERCEDES-AMG COLLECTION

1 AMG FLAT BRIM CAP

Black. 80% polyacrylic/20% wool. 5-panel cap. Adjustable fit. B6 695 4289



1



2-3



4

2 AMG LADIES' T-SHIRT

Black/white. 95% cotton/5% elastane. Short sleeves. Crew neck. White neck band with black AMG logo. White AMG logo print on inside of back. Two-tone AMG 3D logo print on chest. Slim fit. Sizes XS-XL. B6 695 8739-8743

3 AMG MEN'S T-SHIRT

Black/white. 95% cotton/5% elastane. Short sleeves. Crew neck. White neck band with black, woven AMG logo, white AMG logo print with size on inside of back, two-tone AMG 3D logo print on chest. Slim fit. Sizes: XS-XXL. B6 695 8733-8738

4 AMG LADIES' POLO SHIRT

Black/white. 95% cotton/5% elastane. Short sleeves. Two-tone zip. Side vents. Collar and cuffs with single rib. Cuffs with white, knitted stripe. White neck band and side groove band with a black, woven AMG logo. White AMG logo print on inside of back. Black AMG logo print on the zip bar. AMG logo on Autolock zip puller. Slim fit. Sizes: XS-XL. B6 695 8728-8732



5

6

7

8

87

5 AMG MEN'S PERFORMANCE

JACKET Black. 100% polyester. Water and windproof. Breathable. Zips on underside of sleeve for additional ventilation. Purtex® waterproofing. Dual-Protection-System®. Size-adjustable hood. Width-adjustable sleeves. Extended elastic cuffs with thumb hole. Various pockets. Modern fit. White AMG 3D logo print on chest, AMG logo print on the inside on the back, black lining separation band featuring white AMG logo, pocket with white AMG 3D logo print. Sizes: S-XXL. B6 695 8646-8650

6 AMG MEN'S POLO SHIRT

White/black. 95% cotton/5% elastane. Short sleeves. Two-tone zip. Side vents. Single-rib collar. Black neck tape and side vent band with white, woven AMG logo. Black AMG logo print on inside of back. Black AMG logo print on the zip bar. AMG logo on Autolock zip puller. Slim fit. Size: S-XXL. B6 695 8676-8680

7 MEN'S AMG CAP

Black. Outer material 100% polyamide. Lining 100% cotton. Metal clasp for adjusting fit. B6 695 2706

8 AMG ESSENTIALS SUNGLASSES

Gun-bright stainless steel frame, partially brushed. Grey-graded lenses by Carl Zeiss Vision. 100% UV-A/UV-B protection (UV-400). Filter category 3. Anti-reflective coating and hardened. Upper side piece, side piece ends and nose pads with AMG diamond. Made in Germany. B6 695 3478

1 AMG SNAP-HOOK KEY RING

Black/red. Stainless steel/carbon fibre/aluminium. Snap-hook with twist action to open. Three additional mini split rings for quick removal/replacement of individual keys. Length approx. 10 cm. B6 695 3430



2 MERCEDES-AMG GT R TYPO KEY RING

Silver/black/yellow/green. Stainless steel/carbon fibre. Flat split ring with three additional mini split rings for quick removal/replacement of individual keys. Front features replica of original "GT R" lettering on rear of vehicle, back features AMG logo. Designed in Germany. Length approx. 9 cm. B6 695 3340

3 MERCEDES-AMG GT TYPO KEY RING

Silver/black/yellow. Stainless steel/carbon fibre. Flat split ring with three additional mini split rings for quick removal/replacement of individual keys. Front features replica of "GT" lettering on rear of vehicle, back features AMG logo. Designed in Germany. Length approx. 9 cm. B6 695 3339

4 AMG TYPO KEY RING

Silver/black/red. Stainless steel/carbon fibre. Flat split ring with three additional mini split rings for quick removal/replacement of individual keys. AMG logo on front. Designed in Germany. Length approx. 9 cm. B6 695 3338



5 AMG CASE FOR iPhone® 7

Black/silver. Plastic/aluminium. Hard case in real-carbon fibre. Engraved "AMG" lettering. Suitable for wireless charging. B6 695 4031

6 AMG COVER

Black/carbon-coloured. Polycarbonate/polyurethane/carbon fibre. Apertures for camera, buttons and connections. AMG logo. Suitable for wireless charging. iPhone® XR B6 695 6003

iPhone® X/iPhone® XS (not shown) B6 695 3702

Samsung Galaxy S8 (not shown) B6 695 3704

7 AMG BOOKTYPE COVER

Black/carbon-coloured. Polycarbonate/polyurethane/carbon fibre. Apertures for camera, buttons and connections. AMG logo. Suitable for wireless charging. iPhone® X/iPhone® XS B6 695 3701

iPhone® 8 Plus (not shown) B6 695 8625

iPhone® 8 (not shown) B6 695 8624

Samsung Galaxy S8 (not shown) B6 695 3703

8 AMG TO GO CUP, 0.5 L

Black. Stainless steel. Silicone wrist strap. Functional drinking cap. Double-walled. By eva solo for Mercedes-AMG. Diameter approx. 7.5 cm, height approx. 20 cm. Capacity approx. 0.5 l. B6 695 5082

9 AMG ESPRESSO CUPS, SET OF 2

Black/white. Porcelain. Carbon fibre-look design on the outside of cups and on saucers. By Kahla for Mercedes-AMG. Made in Germany. Capacity approx. 90 ml. B6 695 3359

10 AMG MUG

Black/white. Carbon fibre-look design on outside. Porcelain. Magic Grip on base. By Kahla for Mercedes-AMG. Made in Germany. Capacity approx. 350 ml. B6 695 3358

eva solo

8

10

89

9



USE THE WALLET FUNCTION OF YOUR SMARTPHONE

Simply scan the QR code and you will have the opportunity to clearly store the high-quality personal accessories from the Mercedes-Benz Collection on your mobile phone. Once stored, you are always up to date, wherever you are.



1-2

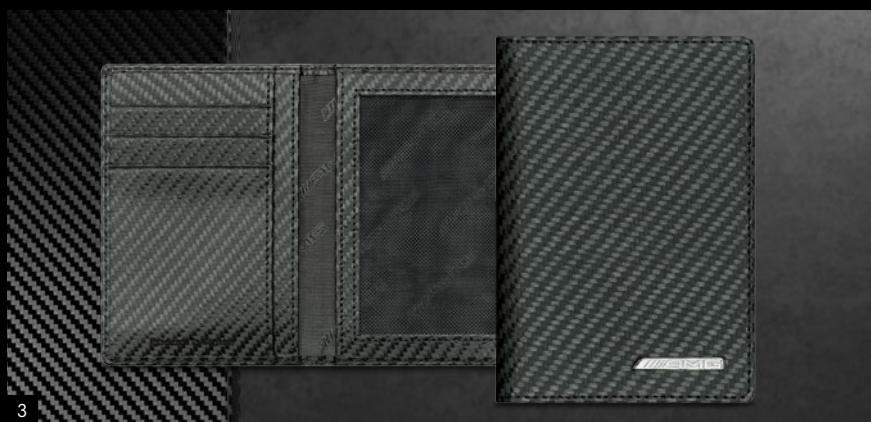

3

3 AMG VEHICLE REGISTRATION WALLET

Black. Carbon-fibre-look leather. Transparent mesh compartment for vehicle registration documents. Various compartments for credit cards. Handmade in Germany. Dimensions approx. 12x0,8x8,5 cm. B6 695 9995

1 AMG BALLPOINT PEN

Black. Brass/carbon fibre. Twist cap. Writes in blue. AMG logo on barrel. Made in Germany. B6 695 3498

2 AMG SOUND BALL-POINT PEN¹

Black. Plastic. Writes in blue. Plays the engine sound of a Mercedes-AMG vehicle at the touch of a button. AMG logo on barrel. B6 695 3552



4

4 MERCEDES-AMG G 65 USB FLASH DRIVE

White/black. Plastic/metal. 16 GB storage capacity. USB 2.0. Compatible with all standard operating systems. Dimensions approx. 7,8x2,6x2,8 cm. B6 695 3229

¹ Available from April 2019.

5 AMG LAPTOP CASE

Black. Carbon-fibre-look leather. For laptop sizes up to 13". High-quality AMG badge, lining material with tonal AMG logo. Dimensions approx. 35 x 25 x 2 cm. B6 695 4469

6 AMG CREDIT CARD

WALLET Black. Carbon-fibre-look leather. Various card and banknote compartments. Handmade in Germany. Dimensions approx. 10.5 x 1.5 x 11.5 cm. B6 695 4552

7 AMG MINI WALLET

Black. Carbon-fibre-look leather. Various compartments inside. Handmade in Germany. Dimensions approx. 10.5 x 1.5 x 7.5 cm. B6 695 9996

8 AMG CARBON KEY CHAIN

Carbon fibre leather/stainless steel. Pull/twist mechanism. Three mini split rings for quick removal/replacement of individual keys. AMG logo on leather Length approx. 10 cm.

Red B6 695 3427

Black (not shown)
B6 695 3428





AMG BUSINESS SUNGLASSES

High-gloss dark green titanium frame, partially brushed. Grey-graded lenses by Carl Zeiss Vision. 100% UV-A/UV-B protection (UV-400). Filter category 3. Anti-reflective coating and hardened. Upper side and side pieces with elaborate embossing. Tension-controlled titanium mono-block hinges. Made in Germany. B6 695 3477

AMG MEN'S LEATHER JACKET

Black with silver grey and red contrasts. Outer material 100% exquisite nappa lambskin, lining: 100% viscose with antibacterial silver finish equipment. Removable collar with zipper. Perforated sections in the shoulder and sleeve area. Modern fit. AMG logo embossing and Heinz Bauer Manufakt logo on left sleeve and on inside on the back. By Heinz Bauer Manufakt for Mercedes-Benz. Sizes 48-56. B6 695 8641-8645

AMG BUSINESS KEY RING

Black/silver grey/gun. Leather/stainless steel. Split ring with three additional mini split rings for quick removal/replacement of individual keys. Made in Germany. Length approx. 11 cm. B6 695 3824

Business unusual.

For all those who love high-performance in their job, this Collection combines business-chic with clear racing accents. The finest leather has the typical AMG touch, feel and look thanks to a perforation and diamond look. The same material also makes wallets even more valuable. Cool gunmetal sets accents and is reminiscent of the high-gloss detachable chrome parts of the AMG models.



93



Mercedes-AMG S 63 4 MATIC + Saloon: Fuel consumption, combined: 11.2 l/100 km; CO₂ emissions, combined: 255 g/km.

THE MERCEDES-AMG COLLECTION



1 AMG WALLET

Black with red topstitching. Cowhide. Various compartments for notes, coins and cards. With embossed AMG logo. Handmade in Germany. Dimensions approx. 12.5x2x9.5 cm. B6 695 3227

2 AMG BUSINESS BAG

Black with red topstitching. Cowhide. Zipped main compartment, various inner compartments. Additional compartment for laptop. Padded, adjustable shoulder strap. Leather loop at back for slotting over towbar of trolley suitcase. Handmade in Germany. Dimensions approx. 41x12x29 cm. B6 695 2986

3 AMG WEEKEND BAG

Black with red contrasting stitching. Leather/nylon. Various compartments on inside and outside. Reinforced base with feet. Detachable, adjustable shoulder strap. Carrying handles and strap modelled on seat belt. With embossed AMG logo. Dimensions approx. 50x28x33 cm. Capacity approx. 34 l. B6 695 4554



4 AMG BELT

Black with red contrasting stitching. Leather / stainless steel. Combination of grained and perforated leather. Handmade in Germany. Adjustable fit. Length approx. 120 cm. B6 695 4551



5 AMG MEN'S POLO SWEATER

Black/silver grey. 60% extra fine merino wool / 35% Lyocell / 5% cashmere. Raglan sleeves. Collar, sleeves and hem rounded off with single-rib. Concealed button band. Slim fit. AMG label in side seam and neck seam. Sizes: S-XXL. B6 695 8666-8670

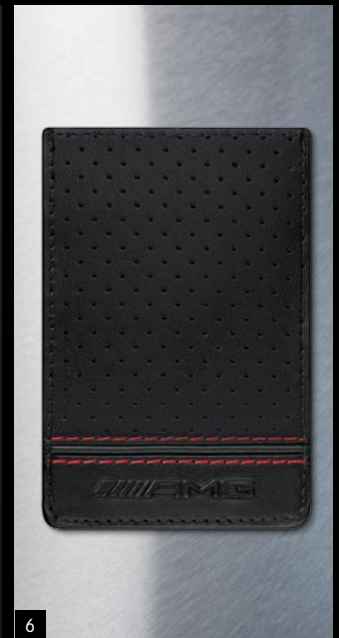

6 CREDIT CARD HOLDER WITH MONEY CLIP

Black with red contrasts. Combination of grained and perforated leather. Stainless steel money clip. AMG inner lining. Handmade in Germany. Dimensions approx. 6.5x0.5x10 cm. B6 695 4541

7

7 AMG MEN'S POLO SWEATER

Black/silver-grey. 70% cotton/20% nylon/10% silk. Single-rib collar, cuffs and hem. Concealed double button band. Slim fit. Woven AMG label on the inside of the neck and in the side seam. Sizes: S-XXL. B6 695 8671-8675

8 AMG I-CLIP THE WALLET

Black with silver-coloured details. Permanently elastic, high-tech plastic ROBUTENSE/original vehicle leather. Patented card system. For up to 12 cards. Money clip. Made in Germany. Dimensions approx. 8.7x6x1.6 cm. B6 695 4784

9 AMG WALLET

Black. Cowhide. RFID protection. Various compartments for notes, coins and cards. Metal AMG badge. Handmade in Germany. Dimensions approx. 12x1.5x9.2 cm. B6 695 4137

8



9



95

I-CLIP
THE WALLET

AMG LANYARD

Red/black. Nylon/metal/plastic. Carbon-fibre-look front part. Click-lock fastener. Snap hook and split ring. Safety clasp. Length approx. 53 cm, width approx. 2 cm. B6 695 3852

AMG LADIES' GILET

Selenite grey/red/white. 100% polyester. Windproof. Warm. Detachable hood. Water-resistant zip. High-closing collar with chin guard. Various pockets. Slim fit. Sizes: XS-XL. B6 695 8563-8567

AMG LADIES' POLO SHIRT

See p. 98

Driving statement.

No other colour has a more powerful effect than red. In the Mercedes-AMG Collection it sets glowing accents together with deep black. The high-quality items of clothing and personal accessories catch the eye as furiously as the AMG Grand Tourer and strike directly into the hearts of motorsport-inspired AMG fans. Every item is intended to give your wardrobe or your home sporty contours.



Mercedes-AMG GT Roadster: Fuel consumption combined: 11.5 l/100 km; CO₂ emissions, combined: 262 g/km.



THE MERCEDES-AMG COLLECTION

1 AMG MEN'S POLO SHIRT

White with grey and black contrasts. 100% cotton piqué. Padding in shoulder area. Black AMG logo embroidered on front and on collar band. Large 3D AMG print on back in black. Sizes: S-XXL. B6 695 6772-6776

2 AMG LADIES' POLO SHIRT

Black with white, red and grey contrasts. 95% cotton/5% elastane single jersey. Button bar with press-studs. Lightly padded shoulders. Slim fit. Large 3D AMG print on back. Sizes: XS-XL. B6 695 8293-8297

3 MEN'S GILET

Selenite grey/red/black. 100% polyester. Detachable hood. Water-resistant zip. High-closing collar with chin guard. Various pockets. Slim Fit. Sizes S-XXL. B6 695 8533-8537

4 AMG COMPACT UMBRELLA

Black/red. Aluminium/polyester. Special water and dirt-repellent coating. Windproof design. Automatic opening and closing. Aluminium shaft. Handle trimmed in perforated leather. Length approx. 58 cm. Diameter when open approx. 105 cm. B6 695 3676

1-2



3



4

A black umbrella with red accents and the AMG logo on the canopy, lying on a dark, textured surface.

5

A black quilted performance jacket with red accents and the AMG logo on the chest, lying on a dark, textured surface.

6

A black polo shirt with red accents and the AMG logo on the collar, lying on a dark, textured surface.

7

5 AMG GUEST UMBRELLA

Black/red. 100% polyester canopy. Perforated leather handle and matt chromed cap. Automatic opening. Special water and dirt-repellent coating. Windproof design. White logo print. Diameter when open approx. 105 cm. B6 695 3677

6 AMG MEN'S PERFORMANCE JACKET

Selenite grey/black. 100% polyester. Wind and water-repellent coating. Detachable hood. Various inside pockets. Adjustable cuffs. Slim fit. White AMG logo print on front. Sizes: S-XXL. B6 695 7495-7499

7 AMG MEN'S PERFORMANCE POLO SHIRT

Black/white/red. 100% Coolmax polyester. Breathable. Side inserts made of textured material. Single-rib collar and cuffs in single rib. Zip fastening. AMG logo on the chest, on the collar band and on the back. White neck band with a woven-in AMG logo. Slim fit. Sizes: S-XXL. B6 695 8553-8557



BEAST of the
GREEN HELL

CHILD'S MERCEDES-AMG GT R CAP

Selenite grey/green. Outer material 99% polyamide/
1% elastane, Lining 100% cotton. Mercedes-AMG GT R
"beast of the green hell" motif print on the front.
AMG logo embossed on metal clasp. Adjustable fit.
B6 695 3957

AMG CHILD'S T-SHIRT

Black/green. 100% cotton. Crew neck. Modern fit.
Green neck band with black AMG logo, white logo
print on inside collar patch, fluorescent "Beast of
the Green Hell" print on the front, AMG logo print
on back in reflective black Sizes 116/122-152/158.
B6 695 4674-4677

AMG MEN'S HYBRID JACKET

See p. 102



AMG GT R Coupé: Fuel consumption combined:
12.4 l/100 km, CO₂ emissions, combined: 284 g/km.



Hellishly chic.

The glowing green indicates the origin of the AMG GT R from afar, which spent a large part of its development time in the green hell of the Nürburgring. This collection generates additional attention. Turning little devils into little angels.





1

1 RIDE-ON BOBBY-AMG GT

Plastic. Lights front and back. Whisper wheels. Suitable for children aged 18 months and over. Manufacturer: BIG Spielwaren.

Solar beam (with LED lighting function) B6 696 2000

Silver-coloured (not shown) B6 696 1999

2 ELECTRIC VEHICLE, MERCEDES-AMG

Maximum speed approx. 4–5 km/h. Age 3+. With EU and universal mains plug. By INJUSA for Mercedes-Benz.

Mercedes-AMG GT S. Solarbeam. With LED and sound. B6 696 3811

Mercedes-AMG GT. White (not shown) B6 696 3810



2



3

3 MERCEDES-AMG GT R USB FLASH DRIVE

Green light magno/black. Plastic/metal. In the shape of the Mercedes-AMG GT R vehicle. Die-cast body. 16 GB storage capacity. USB 2.0. Compatible with all standard operating systems. Dimensions approx. 6.8x3x1.7 cm. B6 695 3476

4 MERCEDES-AMG GT R CAP

In selenite grey with black, green and solar beam yellow contrasts. Outer material 100% nylon. Lining 100% cotton. Black 3D GT R logo embroidered on back. AMG logo embossed on metal clasp. Adjustable fit. B6 695 3207

5 AMG MEN'S HYBRID JACKET

Black/green. Material: Outer material: inside of hood and quilted as well as padded sections: 100% nylon. Hood, collar, sleeves and side inserts in the front and back section made from 100% polyester with fleece and anti-pilling polyester. wadding: PrimaLoft®. High-closing collar. Width- and size-adjustable hood. Adjustable sleeve width. Side pockets. Lightweight. Slim fit. Black AMG 3D logo print on sleeve, green neck band with black AMG logo, AMG logo print with size on inside of back. Sizes: S–XXL. B6 695 8744–8748



4



5

6

6 MERCEDES-AMG GT R CHILD'S UMBRELLA
Black/green. Canopy made from polyester, handle made from sponge rubber. Wrist loop. Mercedes-AMG GT R "beast of the green hell" motif print. Diameter when open approx. 75 cm. Length when closed approx. 62 cm. B6 695 5025

7 AMG CHILD'S WATCH

Green/yellow/black. Stainless steel/silicone. Black dial with AMG GT R motif print and white imprinted dials. Yellow hour and minute hands, green second hand. Green silicon strap with BEAST OF THE GREEN HELL print. Water-resistant to 5 ATM. Diameter 30 mm. Japanese Citizen Miyota 2035 quartz movement. B6 695 4228

8 CHILD'S MERCEDES-AMG GT R GYM BAG

Black/green. Polyester. Zipped compartment on inside and outside. Clip on cord for improved wear comfort. Mercedes-AMG GT R "beast of the green hell" motif print on front, AMG lettering on drawstring with AMG print on inside pocket. Dimensions approx. 38x51 cm. B6 695 3966



Filter categories for sunglasses

Four filter categories are used for sunglasses, based on the degree of tint. Please use the table below to decide which category best suits your needs.

CATEGORY	Tint	Protection/light conditions
1	20-57%	Light protection for overcast days
2	57-80%	Normal protection for summer days in Central Europe
3	80-92%	High protection for expanses of water, beaches and mountains, plus Southern European countries; from 90% tint not suitable for driving!
4	92-97%	Maximum protection for high mountains and glaciers; not suitable for driving!

Clothing sizes

The tables below are designed to help you find your perfect size. It is important to take your measurements correctly. For best results, you should be relaxed and wearing only your underwear. Ideally you should use a tape measure which you should keep close to the body. If you have someone to help you, it will be easier and more precise.

- 1. CHEST:** keeping the tape measure horizontal, measure around the fullest part of the chest
- 2. WAIST:** measure around the waist without drawing the tape measure too tight
- 3. HIPS:** keeping the tape measure horizontal, measure around the fullest part of the hips
- 4. HEIGHT** (for children's clothing): measure from the top of the head to the sole of the feet without shoes

Please note: separate tables are provided for the PUMA brand and the official MERCEDES AMG PETRONAS MOTORSPORT clothing.

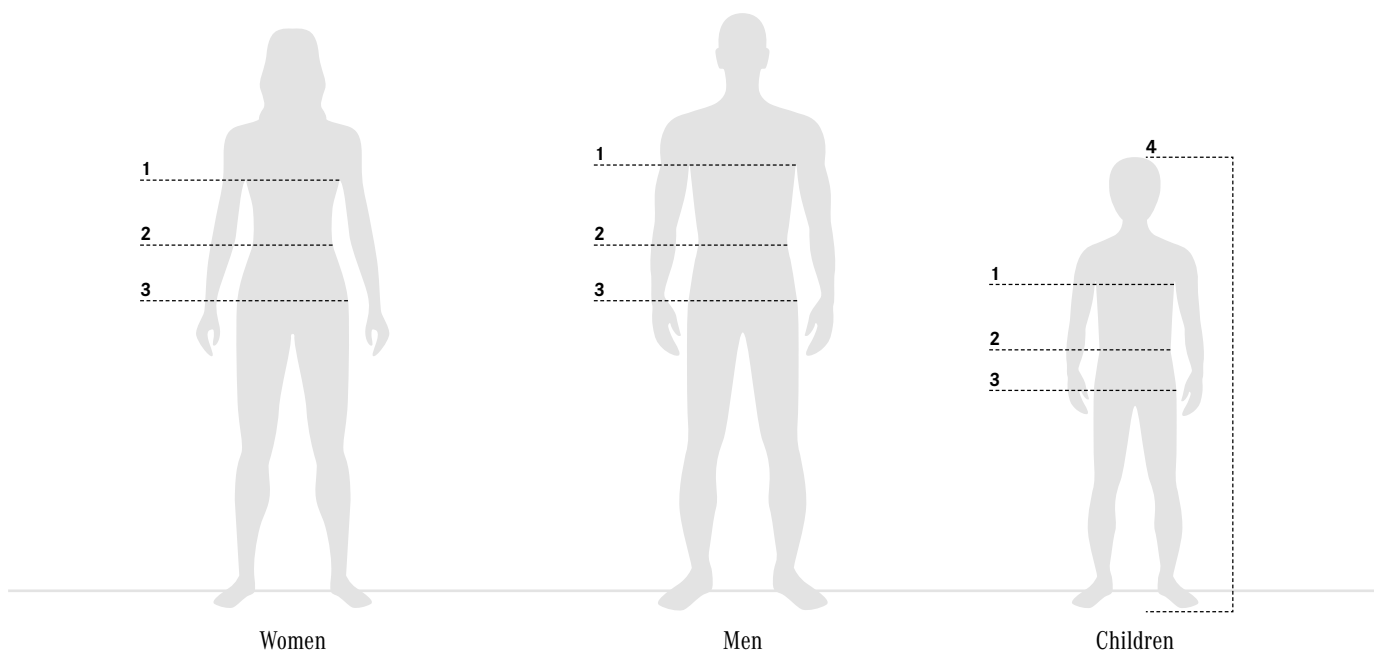

Women

SIZE	XS	S	M	L	XL
CHEST (CM)	77-82	83-88	89-94	95-100	101-106
WAIST (CM)	61-66	67-72	73-78	79-84	85-90
HIPS (CM)	87-92	93-98	99-104	105-110	111-116

Men

SIZE	XS	S	M	L	XL	XXL	XXXL
CHEST (CM)	85-90	91-96	97-102	103-108	109-114	115-120	121-126
WAIST (CM)	78-82	83-87	88-93	94-99	100-105	106-111	112-117
HIPS (CM)	89-94	95-100	101-106	107-112	113-118	119-124	125-130

Children

SIZE	116/122	128/134	140/146	152/158
AGE (YEARS)	6-7	8-9	10-11	12
CHEST (CM)	58-62	63-68	69-74	75-80
WAIST (CM)	55-56	57-59	60-62	63-65
HIPS (CM)	62-67	68-73	74-80	81-87
HEIGHT (CM)	114-125	126-137	138-149	150-161



Women

SIZE	XS	S	M	L	XL
CHEST (CM)	82	86	91	96	101
WAIST (CM)	65	68	74	80	86
HIPS (CM)	93	96	101	106	112

Men

SIZE	XS	S	M	L	XL	XXL
CHEST (CM)	84	92	100	108	116	124
WAIST (CM)	76	82	88	96	104	114
HIPS (CM)	88	95	102	110	118	126

Children

SIZE	104	116	128	140	152
CHEST (CM)	56	59	64	70	76
WAIST (CM)	53	55	59	63	67
HIPS (CM)	59	63	69	75	81
HEIGHT (CM)	104	116	128	140	152

Women

SIZE	XXS	XS	S	M	L	XL	XXL
CHEST (CM)	78	82	86	91	96	101	107
WAIST (CM)	62	65	68	74	80	86	114
HIPS (CM)	90	93	96	101	106	112	118

Men

SIZE	XXS	XS	S	M	L	XL	XXL	XXXL
CHEST (CM)	89	91	93	97	102	112	120	130
WAIST (CM)	77	79	81	85	92	105	114	122
HIPS (CM)	92	94	97	99	103	110	117	124

Children

SIZE	116/122	128/134	140/146	152/158
AGE (YEARS)	6-7	8-9	10-11	12
CHEST (CM)	58-62	63-68	69-74	75-80
WAIST (CM)	55-56	57-59	60-62	63-65
HIPS (CM)	62-67	68-73	74-80	81-87
HEIGHT (CM)	114-125	126-137	138-149	150-161

Women

SIZES	INTERNATIONAL EQUIVALENTS				
	DEU	UK	FRA	ITA	SP
XXS	32	6	34	36	36
XS	34	8	36	38	38
S	36	10	38	40	40
M	38	12	40	42	42
L	40	14	42	44	44
XL	42	16	44	46	46
XXL	44	18	46	48	48

Men

SIZES	INTERNATIONAL EQUIVALENTS				
	DEU	UK	FRA	ITA	SP
XXS	38	38	38	38	38
XS	40/42	40/42	40/42	40/42	40/42
S	44/46	44/46	44/46	44/46	44/46
M	48/50	48/50	48/50	48/50	48/50
L	52/54	52/54	52/54	52/54	52/54
XL	56/58	56/58	56/58	56/58	56/58
XXL	60/62	60/62	60/62	60/62	60/62

Children

SIZES	INTERNATIONAL EQUIVALENTS				
	DEU	UK	FRA	ITA	SP
XXS	104	3/4	4	104	4
XS	116	5/6	6	116	6
S	128	24/25	8	128	8
M	140	26/28	10	140	10
L	152	30/32	12	152	12
XL	164	32/34	14	164	14
XXL	176	34/36	16	176	16

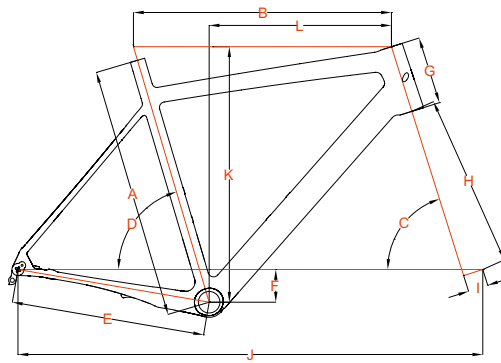

Size - Crater Lake Fitness Bike/Aventura Trekking Bike

	S	M	L	XL
HEIGHT (IN CM)	158-168	168-178	178-188	188-198
A FRAME SIZES	450 mm	500 mm	550 mm	600 mm
B TOP TUBE	570 mm	580 mm	595 mm	610 mm
C HEAD TUBE ANGLE	71°	71.5°	71.5°	71.5°
D SEAT TUBE ANGLE	74°	73.5°	73°	72.5°
E CHAIN STAY LENGTH	465 mm	465 mm	465 mm	465 mm
F BB DROP	60 mm	60 mm	55 mm	55 mm
G HEAD TUBE	135 mm	135 mm	170 mm	220 mm
H FORK LENGTH	465 mm	465 mm	465 mm	465 mm
I FORK RAKE	45 mm	45 mm	45 mm	45 mm
J WHEELBASE	1093 mm	1092 mm	1104 mm	1114 mm
K STACK	613 mm	616 mm	644 mm	691 mm
L REACH	394 mm	398 mm	398 mm	392 mm

Size - Raven Elite Carbon Mountain Bike

	XS	S	M	L
HEIGHT (IN CM)	158-168	168-174	174-184	184-196
A FRAME SIZES	380 mm	420 mm	460 mm	500 mm
B TOP TUBE	566 mm	592 mm	608 mm	629 mm
C HEAD TUBE ANGLE	69.5°	69.8°	69.8°	69.8°
D SEAT TUBE ANGLE	74.5°	74.5°	74.5°	74.5°
E CHAIN STAY LENGTH	425 mm	435 mm	435 mm	435 mm
F BB DROP	47 mm	68 mm	68 mm	68 mm
G HEAD TUBE	100 mm	104 mm	107 mm	130 mm
H FORK LENGTH	487 mm	501 mm	501 mm	501 mm
I FORK RAKE	44 mm	44 mm	44 mm	44 mm
J WHEELBASE	1074 mm	1100 mm	1116 mm	1139 mm
K STACK	580 mm	620 mm	623 mm	644 mm
L REACH	405 mm	420 mm	435 mm	450 mm

Lanybook®



eva solo



zippo



MiaCara

flip*flop®
originals



BREE
SINCE 1970



LIPSONE
THE WALLET



Samsnite



LAMY
Design. Made in Germany.



GARMIN

TOMMY HILFIGER



INJUSA

As at: March 2019. Please note: changes may have been made to the products since this publication went to press (12/2018). The manufacturer reserves the right to make changes to the design, form, colour and specification during the delivery period, provided these changes, while taking into account the interests of the vendor can be deemed reasonable with respect to the purchaser. Where the vendor or the manufacturer uses symbols or numbers to describe an order or the subject of an order, no rights may be derived solely from these. The illustrations may include accessories and items of optional equipment which are not part of the standard specification. Colours may differ slightly from those shown, owing to the limitations of the printing process. This publication may include products and services which are not available in certain countries. Information given regarding statutory regulations, legal requirements and taxation and the consequences thereof applies to the Federal Republic of Germany only and is correct at the time of going to print. Please consult your Mercedes-Benz Retailer for final details.

Provider: Daimler AG, Mercedesstr. 137, 70327 Stuttgart
Mercedes-Benz Customer Solutions GmbH – A Daimler Company

3240 - 0005 - 02-01/0319 Printed in the Federal Republic of Germany
© 2019 Mercedes-Benz Customer Solutions GmbH. All rights reserved.